



INSTRUCTION MANUAL FT-77

Downloaded by

Amateur Radio Directory

YAESU MUSEN CO., LTD.

C.P.O. BOX 1500
TOKYO, JAPAN

TABLE OF CONTENTS

	(Page)
GENERAL DESCRIPTION	1
SPECIFICATIONS	2
SEMICONDUCTORS	3
ACCESSORIES	3
FRONT PANEL CONTROLS AND SWITCHES	4
TOP ACCESS PANEL CONTROLS	6
REAR PANEL CONNECTIONS	7
INSTALLATION	8
INTERCONNECTIONS	10
CONNECTOR WIRING	11
MICROPHONE CONNECTIONS	12
OPERATION	14
INSTALLATION OF OPTIONS	20
BLOCK DIAGRAM	24
CIRCUIT DESCRIPTION	25
ALIGNMENT	31
PARTS LIST	39

FT-77

THRIFTY HF TRANSCEIVER



GENERAL DESCRIPTION

The FT-77 is an all solid state transceiver for SSB and CW operation on all amateur bands between 3.5 and 30 megahertz. FM operation is also possible when the optional FM unit is installed. Nominal power output for SSB and CW is 100 watts (85 watts on 10 meters, 50 watts FM).

Utilizing the latest engineering and manufacturing advances garnered from recent technological developments, the FT-77 is intended to offer the essential modern operating features in the most economical, reliable and compact HF transceiver available today.

Reliability and quality control have been increased to a degree beyond that previously attainable in amateur equipment, while production costs have been reduced considerably, due to the new CAD/CAM (computer aided design/computer aided manufacturing) system employed for the designing and assembly of the FT-77. Computer-designed circuit board layouts ensure the high level of reliability in the smallest possible space, while automatic (robot) parts insertion and soldering vastly improve quality control and reduce costs.

The simplicity of the design of the FT-77 results in fewer parts that could cause problems, and the extremely compact size and convenient control layout make this transceiver ideal for mobile operation, or as the heart of a complete base station with the FP-700 AC Power Supply.

Special standard features not immediately obvious include dual selectable noise blankers, self-contained SWR metering, and the capabilities for simple addition of options such as a narrow CW filter, 25 kHz Marker Unit, fixed frequency crystal, FV-700DM digital scanning VFO and memory system, FTV-700 V/UHF Transverter, and the FC-700 Antenna Tuner.

Please read this manual carefully before operating the transceiver, so as to derive optimum performance and enjoyment from the FT-77.

SPECIFICATIONS

GENERAL

Frequency coverage:

All amateur bands between 3.5 and 29.9 MHz,
including the three WARC bands

Operating modes:

A3J (LSB/USB), A1 (CW)
F3 (FM) optional

Power requirements:

13.5V DC; 1A receive, 20A transmit

Size:

240(W) x 95(H) x 300(D) mm,
including heat sink

Weight:

6 kg (13.2 lb)

TRANSMITTER

Power input:

240W DC for nominal 100W output (85W on
10 meter band)

Spurious radiation:

Less than -40 dB

Carrier suppression:

Better than 40 dB

Unwanted sideband suppression:

Better than 50 dB (W/1 kHz modulation)

Audio response:

350–2700 Hz (@ -6 dB)

Stability:

Less than 300 Hz drift during the first 30
minutes after a 10 minute warmup, less than
100 Hz every 30 minutes thereafter

Microphone input impedance:

500–600 ohms

RECEIVER

Circuit type:

Single conversion superheterodyne
(double conversion for FM, when installed)

Intermediate frequency:

8987.5 kHz (plus 455 kHz for FM)

Sensitivity:

0.3 μ V for 10 dB S+N/N (SSB and CW-W)

0.15 μ V for 10 dB S+N/N
(with CW-N option)

0.7 μ V for 12 dB SINAD
(FM, with FM option)

Image rejection:

More than 70 dB

IF rejection:

More than 50 dB

Selectivity (@ -6/-60 dB):

2.4/5 kHz for SSB, CW-W

600/1300 Hz with CW-N option

12/24 kHz with FM Unit option

Audio output:

3W (4-ohm internal speaker, @10% THD)

External speaker impedance:

4–16 ohms

Downloaded by



Amateur Radio Directory

SEMICONDUCTORS

FCD		FETs:		Diodes:		RD7.5EB1 (Zener Diode)	1
FIP8B7	1	2SK125	2	1S2236	1	RD8.2EB1 (Zener Diode)	1
		2SK241GR	2	(Varactor Diode)		TLR210 (LED)	2
ICs:		3SK73GR	6	ISS97	6	YZ033 (Zener Diode)	1
MB3713	1			(Schottky Barrier Di.)		2SC1959Y	2
MC4044P	1	Transistors:		ISS106	14	2SC2166	1*
MC14011BCP	2	2SA733AQ	20	(Schottky Barrier Di.)		2SC2290	2**
MSL9520RS	1	2SA1005K	19	1SV103	9	2SC2395	2**
ND487C2-3R (Ring-Module)	1	2SB772Q	4	(Varactor Diode)		2SC2407	1
TA7063P	1	2SB774	5	10D1 (Si Diode)	2	2SC2458Y	18
TA7310P	1	2SC380TM-Y	8	10D10 (Si Diode)	4**	2SC2509	2*
VFO-1	1	2SC458C	18	MA162 (Si Diode)	5	2SC2562Y	1
μPC78L05	1	2SC496-O	1	MA190 (Si Diode)	120	2SD235Y	1**
μPC78L08	1*	2SC732TM-GR	3	MV11 (Varistor Diode)	1*	2SD882Q	1*
μPC78L08	1**	2SC1589	1**	MV13 (Varistor Diode)	1		
μPC7808H	1**	2SC1923-O	4	RD5.6EB2 (Zener Diode)	2	*: 10W MODEL	
				RD6.2EB2 (Zener Diode)	2	** : 100W MODEL	

ACCESSORIES

DC POWER cord	(T9014420)	1
FUSE 20A	(Q0000009)	1
LONG LEGS	(R3086910)	2
PAD	(R7088090)	2

On the bottom the Unit, the special front feet allow selection of two different viewing angles. In addition, a pair of extra-long legs are provided in the accessory package, as well as rubber slip-stop inserts. The standard legs can be replaced by the long legs by removing the screws affixing the feet, and exchanging legs. The low viewing angle will remain the same. The slip-stop inserts are intended for installation only when necessary to prevent slippage, such as when the Unit is located on top of another piece equipment. Of course, when the extension legs are lowered, the slip-stop inserts are not needed.

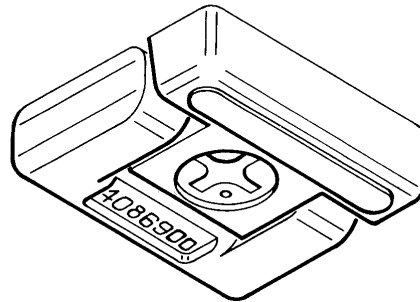
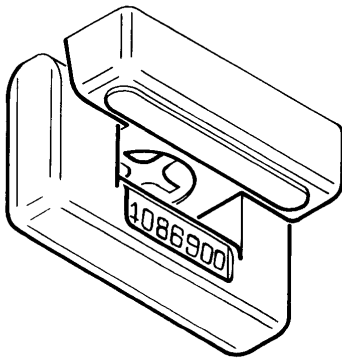

FRONT PANEL CONTROLS AND SWITCHES

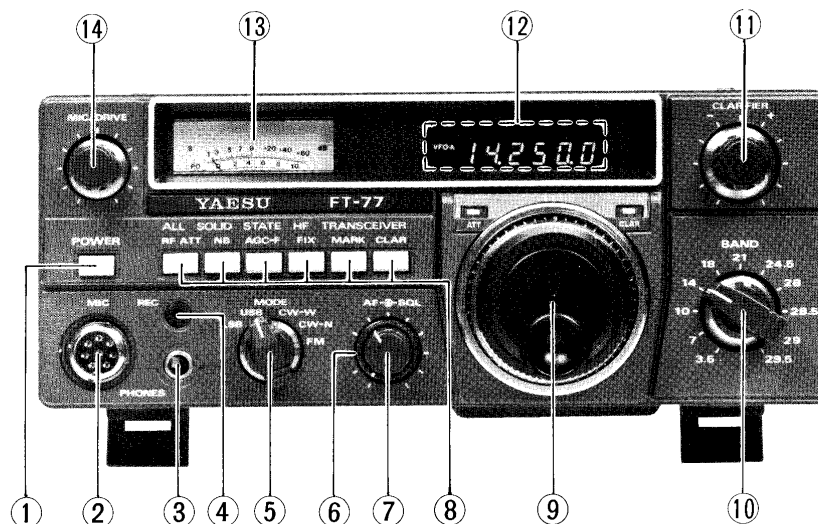

1. POWER

Press this button to switch the transceiver ON (in position), and press again to switch OFF (out position).

2. MICROPHONE Jack

This 8-pin connector includes connections for the transmitter audio input, PTT switch, and scanning controls (for use when the FV-700DM or FV-707DM External Scanning VFOs are connected).

3. PHONES Jack

Either stereo or monaural headphones using standard 1/4-inch plugs may be connected to this jack. In either case, audio will be heard in both sides of the headphones while the internal speaker (and external speaker, if connected) will be disabled.

4. RECORD Jack

This jack accepts a standard 2-conductor mini phone plug, and provides audio output for tape recording purposes at a constant level regardless of the setting of the AF volume control. The level is approximately 70mV_{rms} at 50K ohms im-

pedance.

5. MODE Selector

The mode of operation for both the transmitter and receiver is selected by this switch. The CW-N position selects the optional narrow CW filter, when installed. Otherwise, operation in this mode is identical to CW-W. FM operation requires the optional FM Unit.

6. SQL (Squelch)

This control is used to set the threshold level for the receiver squelch during FM operation (when the FM Unit is installed). It is deactivated in the other modes.

7. AF (Volume)

Adjust this control for the desired volume level during receive.

8. Push Button Switches

RF ATT

When this button is depressed the receiver input is attenuated approximately 20dB, thus inhibiting overload from strong signals.

The ATT LED near the Tuning Knob will remain lit while the attenuator is in the circuit.

NB

When ignition noise or the woodpecker interferes with received signals, press this button to activate the noise blanker. The NB W-N switch under the top access panel can now be used to select the most effective blanking pulse for the type of noise encountered. When the blanker is not needed, this button should be set to the OFF (out) position.

AGC-F

Press this button to select fast AGC action for the receiver. When this button is not depressed, slow AGC is selected.

FIX

This button selects fixed-frequency operation when an optional fixed-frequency crystal is installed. When this button is pressed, the VFO is disabled and the letter "F" appears at the left side of the digital display. If this button is pressed when no crystal is installed (under the top access panel), the frequency display will be blank.

MARK

This button activates the optional Frequency Marker Generator, when installed. The Marker produces unmodulated calibration signals at the receiver input every 25 kHz throughout the range of the receiver.

CLAR

Press this button to activate the clarifier, which allows adjustment of the receiving frequency (via the CLARIFIER control) without changing the transmit frequency. The CLAR LED near the tuning knob will be lit when the clarifier is on.

9. Tuning Knob

Turn this knob to change the operating frequency of the transceiver. One full rotation corresponds with approximately 15 kHz of frequency change.

10. BAND Selector

Set this selector to the desired operating band while receiving. Never change bands while transmitting, as this can damage the equipment.

11. CLARIFIER

When the clarifier system is activated by the CLAR push button, this control adjusts the receive frequency up to approximately ± 2.5 kHz from the transmit frequency.

12. Digital Display

The operating frequency is shown here to the nearest 100 Hz. Also, on the left side of the display, the source of the frequency being displayed is indicated by either "VFO-A", indicating the FT-77 internal VFO; "VFO-B", indicating an external VFO such as the FV-700DM; or "F", indicating fixed frequency crystal control. In all cases, the displayed frequency is that of the carrier (or suppressed carrier), so the display will read differently depending upon the selected mode.

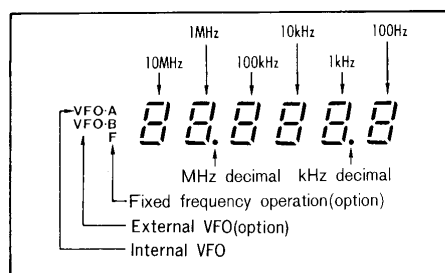

13. Meter

The meter indicates signal strength in S-units during receive, while either ALC, relative forward power output (FWD), or reflected power (REF) may be selected for indication during transmission (by the ALC-REF-FWD switch under the top access panel).

14. MIC/DRIVE

For SSB transmission, this control adjusts the gain of the transmit audio stages. For CW and FM, this control adjusts the transmitter drive power level.

TOP ACCESS PANEL CONTROLS

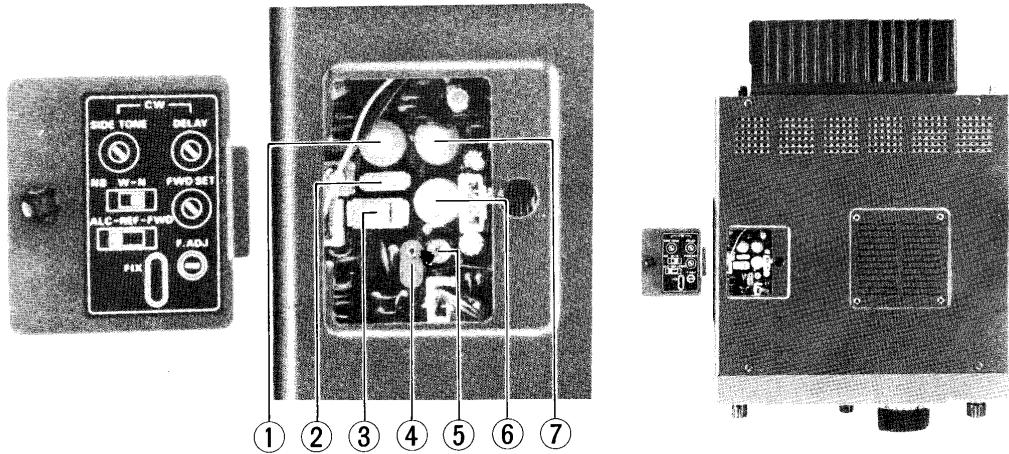

Labelling for these controls is provided on the inside surface of the top access panel cover. To open the cover, lift the center pin of the Nyloc latch slightly, and remove the small panel.

1. SIDE TONE

This control adjusts the volume level of the CW sidetone produced during CW operation.

2. NB W-N

This 2-position slide switch selects either wide or narrow blanking pulse widths for the noise blanker.

3. ALC-REF-FWD

This 3-position slide switch selects the function of the front panel meter during transmission.

4. FIX

This is the socket for an optional crystal when fixed frequency operation is desired.

5. F. ADJ

This control provides fine adjustment of the fixed frequency crystal oscillator for setting the transceiver to the exact frequency desired. It is deactivated unless an optional crystal is installed in the FIX socket.

6. FWD SET

This control adjusts the sensitivity of the meter circuit used in the FWD and REF functions when measuring SWR.

7. DELAY

This control adjusts the transmit-to-receive switching time for semi break-in CW operation.



REAR PANEL CONNECTIONS

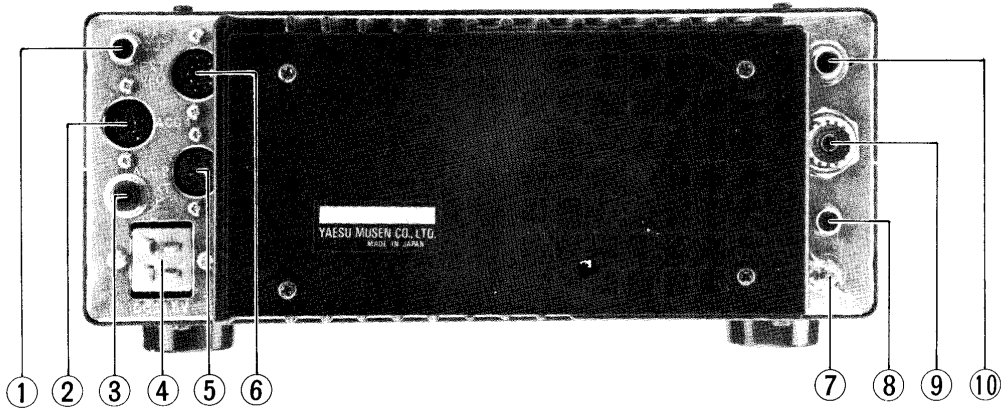

1. RF OUT

This RCA jack provides low level RF output for use with a transverter such as the FTV-700. Output is 220 mV_{rms} at 50 ohms.

2. ACC 1

This 6-pin DIN jack provides the switching and ALC connections necessary when using a phone patch or linear amplifier.

3. EXT SP

A 4–16 ohm external speaker may be connected to this 1/8-inch mini phone jack. Inserting a plug into this jack disables the internal speaker.

4. DC 13.5V

This connector accepts DC power for the transceiver. Never apply AC voltage here.

5. ACC 2

This 7-pin DIN jack provides up/down scanning control, TX audio input, PTT and TX13.5V signals for an external VFO such as the FV-700DM or FV-707DM.

6. EXT VFO

This 8-pin DIN jack accepts the frequency control signals from, and provides power for, an external VFO.

7. GND

This terminal should be connected to a good earth ground along with other station equipment for best performance and safety.

8. DC 8V

This RCA jack provides 8V DC for the FC-700 Antenna Tuner.

9. ANT

This is a type M connector for the antenna, antenna tuner or linear amplifier input. Only coaxial cable with the proper plug should be connected at this point. Impedance must be as close as possible to 50 ohms at the operating frequency for best performance.

10. KEY

This standard 2-conductor 1/4-inch phone jack is for connection of a straight key or electronic keyer output for CW operation. Key down current is 0.4mA (@<0.5V), and key up voltage is 1.5V.

INSTALLATION

PRELIMINARY INSPECTION

Upon opening the packing carton, immediately give the transceiver a thorough visual inspection. Check to ensure that all controls and switches move freely, and that the cabinet is free from any signs of damage. If any damage is noticed, immediately document the damage completely and contact the shipping company. Save the packing carton and packing material for possible future use.

BASE STATION INSTALLATION

Power Supply

The FT-77 requires a power source of 13.5 (± 1.5) volts DC, capable of up to 20 amps on voice peaks. The FP-700 Power Supply is designed for this purpose, and may be used with AC line voltages of 100, 110, 117, 200, 220 or 234 VAC. However, before the FP-700 or any other suitable power supply is connected to the transceiver or AC line, it should be inspected to ensure that the power transformer is properly connected for the local line voltage, and that the correct fuse is installed. The FP-700 requires a 6A fuse for 100, 110 or 117 VAC, or a 3A fuse for 200, 220 or 234 VAC. NEVER CONNECT AC POWER, OR DC VOLTAGE ABOVE 15V, TO THE FT-77.

Make certain that the POWER switch on the front panel of the FT-77 is OFF (out) before connecting power to the transceiver, and double check to make sure that the polarity of the connections is correct before switching the transceiver on.

NOTICE

THE FOLLOWING ABUSES MAY CAUSE DAMAGE TO THE EQUIPMENT WHICH WILL VOID THE WARRANTY:

1. CONNECTION OF AC VOLTAGE OR IMPROPER DC VOLTAGE DIRECTLY TO THE TRANSCEIVER.
2. INCORRECT (REVERSED) POLARITY POWER CONNECTION.
3. USE OF AN IMPROPER FUSE.

Ground and Location

In base station installations the GND terminal on the rear panel of the FT-77 should be connected by a heavy braided cable to a good earth ground. Best performance will usually result when the grounding cable is less than 10 feet (3 meters) long, where possible. All station equipment should be connected to the same grounding point close to the transceiver, or linear amplifier, if used.

Locate the transceiver so that air can flow freely around the heat sink, and under and over the case. Whenever possible, use the front feet in their extended position as shown on page 4, and avoid placing papers or books on top of the transceiver. Do not place the FT-77 on top of a heat generating device such as a linear amplifier.

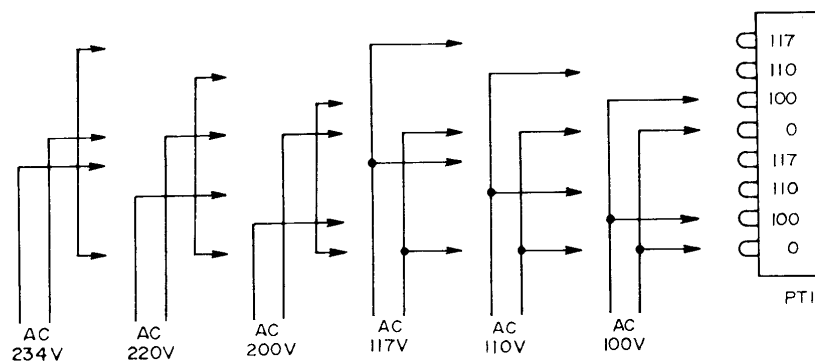

FP-700 POWER TRANSFORMER PRIMARY CONNECTIONS

Antenna

The FT-77 is designed for use with any antenna system which has a 50-ohm resistive impedance at the operating frequency. An automatic final protection (AFP) circuit is included in the transmitter stages to protect the final transistors by automatically reducing the transmitter power output when a high SWR is present. At an SWR of 2:1 for example, only about 90% of the full rated output power will be available.

In spite of this protection circuit, the FT-77 should never be switched to transmit when no antenna or dummy load is connected. Use 50-ohm coaxial cable to connect the transceiver to the antenna or load, and if the SWR is too high to permit the desired output power, connect an antenna tuner such as the FC-700 between the transceiver and the antenna.

MOBILE INSTALLATION (Negative Ground Vehicles Only)

The DC cable for mobile installation is supplied with the transceiver. Please review the NOTICE on the previous page before making power connections. For best results, the DC cable should be connected directly to the vehicle battery, rather than to the ignition circuitry or accessory circuitry. Route the cable as far away from ignition cables as possible, while still keeping the DC cable length as short as practical. Cut off any unnecessary length of the cable in order to keep cable losses to a minimum.

Make certain that the cable is not connected to the transceiver until after the proper connections are made to the battery: the RED cable lead to the POSITIVE battery terminal, and the BLACK lead to the NEGATIVE terminal. The Power Plug Connector Wiring (page 11) shows the proper polarity of the connections to the FT-77. The positive RED wire must include a 20 amp fuse.

Before connecting the DC cable to the transceiver, check the voltage across the battery terminals with the engine running fast enough to show a charge. If this voltage exceeds 15 volts the automobile voltage regulator must be adjusted to reduce the charging voltage. Once the charging voltage at the battery terminals is determined to be correct, make sure that the POWER switch on the front panel of the FT-77 is OFF, and connect the DC cable to the transceiver.

Always check to ensure that the FT-77 POWER switch is in the OFF (out) position before starting the engine.

Mounting

The optional MMB-16 Mobile Mounting Bracket is available for under-dash installation. This bracket can be used to mount the FT-77 alone, or the FT-77 plus the FV-700DM External Scanning VFO or FC-700 Antenna Tuner; or all three together. See page 23 for installation details.

The mobile mounting position should allow about 8 inches (20 cm) of clearance around the heat sink to permit free air circulation. Avoid locations directly in the path of the heater ducts.

Mobile Antenna

Please review the Antenna paragraphs in the preceding Base Station Installation section. An antenna tuner such as the FC-700 is particularly desirable for mobile installations, where the shortened antenna elements have very narrow bandwidth. Yaesu offers the RSL series of HF mobile antennas.

Scan by Dan

INTERCONNECTIONS

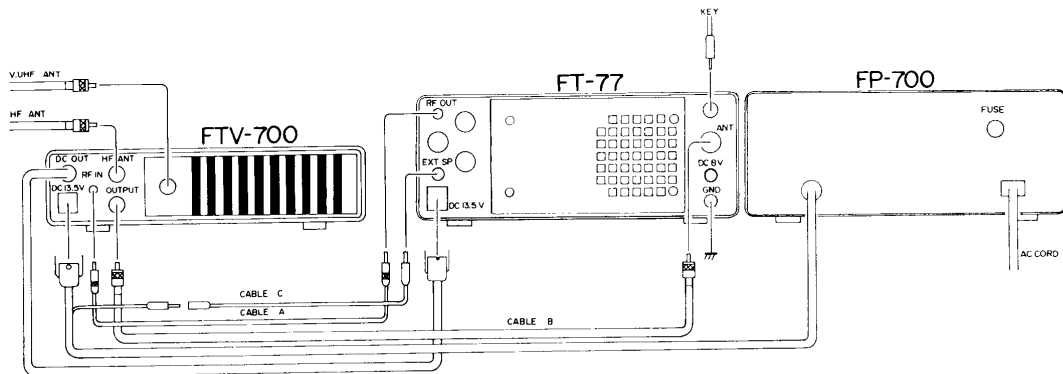
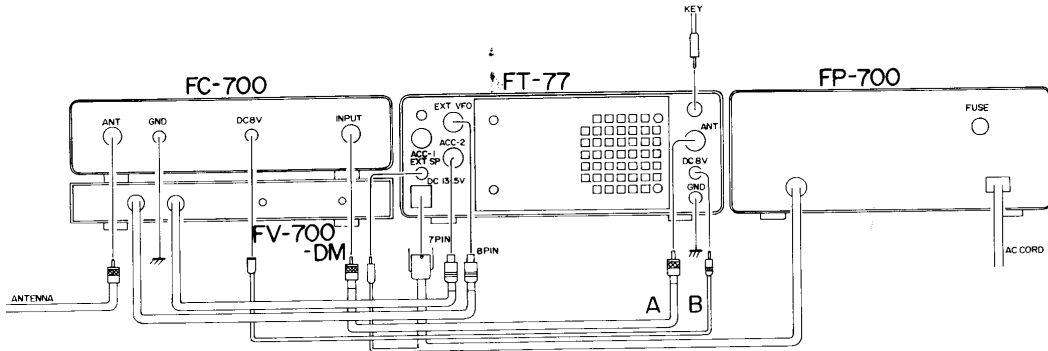
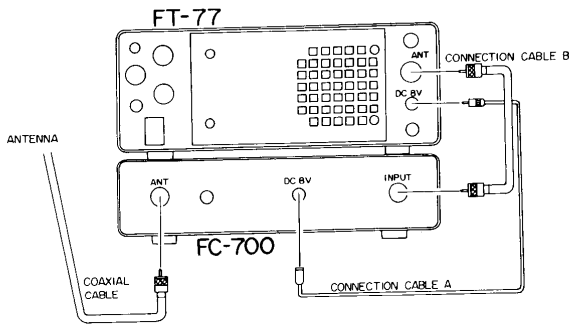
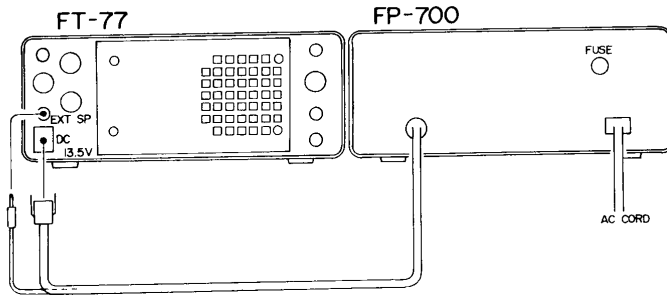

CONNECTOR WIRING

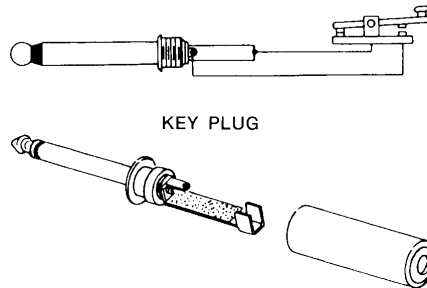
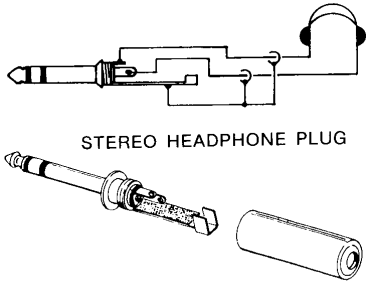
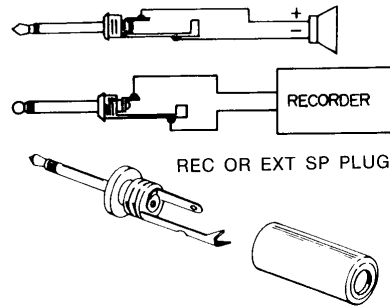
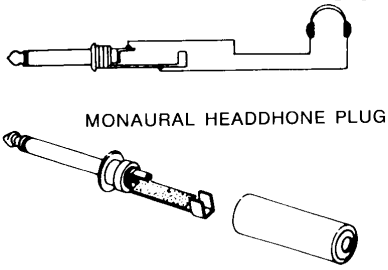

ACC-1 PLUG

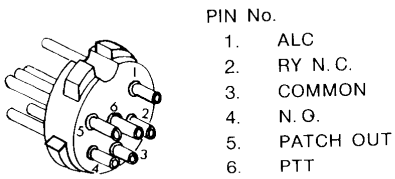

ACC-2 PLUG

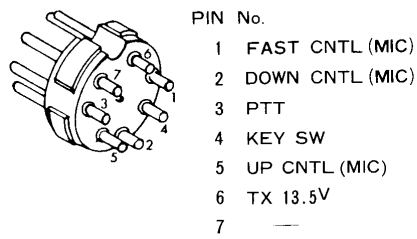

EXT VFO PLUG

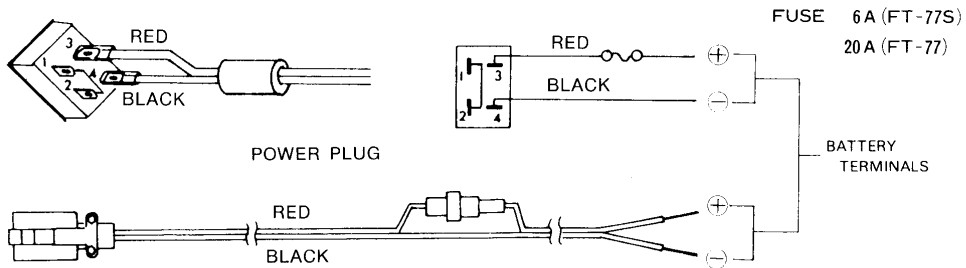
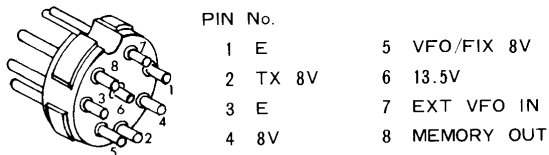

MICROPHONE CONNECTIONS (Microphones optional)

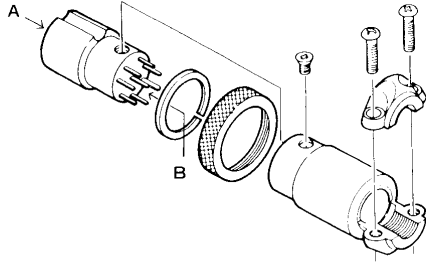

MD-1B8

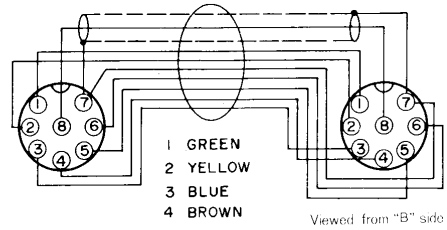
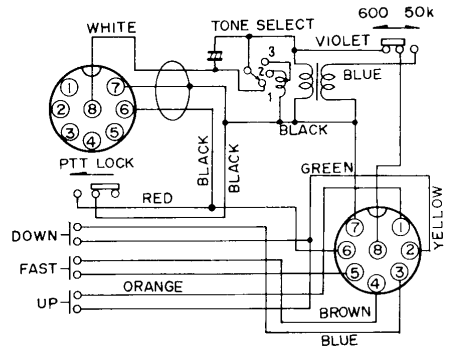
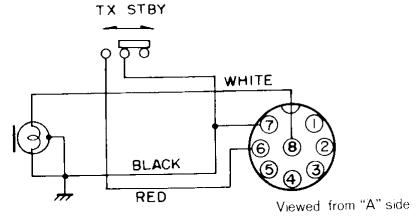

- 1 GREEN
 - 2 YELLOW
 - 3 BLUE
 - 4 BROWN
 - 5 ORANGE
 - 6 RED
 - 7 BLACK
 - 8 WHITE
- SHIELDED



MH-1B8

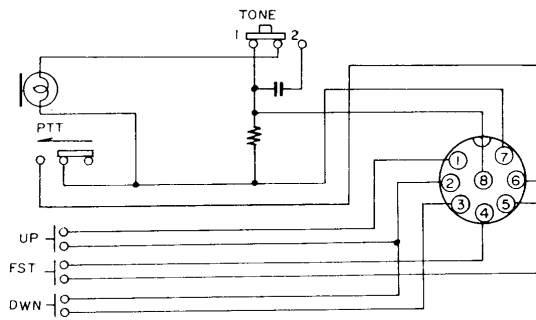

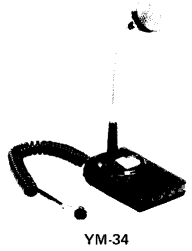

YM-34

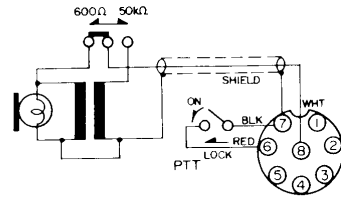

Viewed from "A" side

YM-34 MICROPHONE CONNECTIONS



YM-35

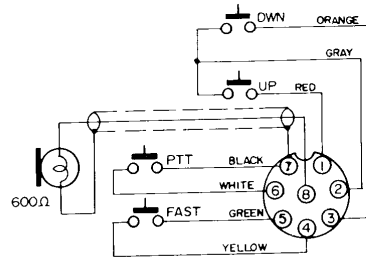

YM-35 MICROPHONE CONNECTIONS



YM-36

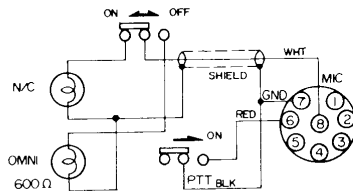

YM-36 MICROPHONE CONNECTIONS



YM-37

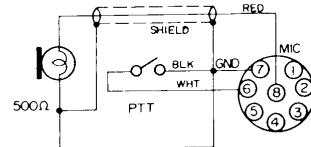

YM-37 MICROPHONE CONNECTIONS



YM-38

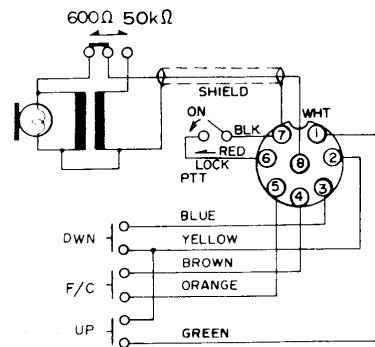

YM-38 MICROPHONE CONNECTIONS

OPERATION

The all solid state design of the FT-77 makes the tuning procedure very simple. However, care should be exercised to follow the proper procedure to ensure that spurious signals are not transmitted.

Before switching the transceiver on, check that all interconnections, power supply voltage and fuse are correct.

RECEIVING

1. Preset the controls and switches as follows:
MODE USB (above 10 MHz), or LSB
AF adjust as needed
Push Buttons.. all OFF (out)
BAND as desired
2. Be certain that the antenna is connected to the ANT jack, and then switch on the Power Supply, and finally the transceiver POWER switch.
3. Adjust the AF control for comfortable volume, and rotate the Tuning Knob to obtain the desired frequency on the Digital Display.

RF Attenuator

If very strong signals are encountered, distortion or intermodulation may occur in the receiver. In many cases this can be remedied by depressing the RF ATT button to activate the attenuator. This may also prove helpful when very high noise levels are present, such as low frequency reception with a very large antenna. The ATT LED above the Tuning Knob will be lit whenever the RF ATT is on.

Noise Blanking

When pulse type noise is received, press the NB button to activate the noise blanker. Automobile ignition noise and other short-pulse noise generated by electrical discharge, such as from electric motors, is most effectively blanked when the NB W-N switch (under the top access panel) is set to the "N" position. Noise with a longer pulse duration, particularly from the "woodpecker" over-the-horizon radar, is most effectively blanked by setting the NB W-N switch to "W". However, some degradation of received signal quality may also be

noticed when this position is used and the noise is not present. Best performance is obtained by setting the NB W-N switch to the position most needed for the individual operator's location and requirements, and then only pressing the NB button when blanking is required.

Automatic Gain Control (AGC)

Press this button for normal CW reception, or when fast fading (QSB) is noticed on the received SSB signal. Also, when tuning around for weak signals the AGC-F (depressed) position may be useful. For regular SSB QSOs with reasonably strong stations the most comfortable reception will generally be found with this button in the out (slow AGC) position. During FM operation this button will effect the speed of the S-meter while having no effect on the received signal itself.

FIXed Frequency Operation

When an optional fixed frequency crystal is installed (in the FIX socket under the access panel), pressing the FIX button will cause the frequency control of the FT-77 to change from the VFO to the crystal. The digital display will also show an "F" at the left side, instead of "VFO-A" which appears normally when the internal VFO is in operation. Please refer to page 18 for operating details and instructions on how to determine which crystal to install.

MARKer Operation

When the optional Marker Unit is installed, pressing this button will cause steady carrier signals to appear at every 25 kHz point throughout the tuning range of the transceiver. These signals are useful for checking frequency alignment. During normal operation, however, the MARK button should be in the off (out) position, or unwanted mixer products may make reception difficult. Also, the MARKer generator may produce some low-level signals at odd frequencies. These can be identified by their level, and should be ignored.

CLARifier

During normal tuning, the CLAR button should be off (out), and the CLARIFIER control set to the 12 o'clock position. After making two-way contact with another station the CLAR button may be

pressed and the CLARIFIER control adjusted for the most pleasant receiving tone. This will not affect the transmitting frequency of the FT-77, so the other operator will not be forced to retune. If the transmitting frequency of the other station drifts, simply follow his signal with slight adjustment of the CLARIFIER control.

When the contact is finished, before changing frequency or taking another call, return the CLARIFIER control to the 12 o'clock position and set the CLAR button to the off (out) position. This will extinguish the CLAR LED.

CW Reception

When the optional CW-N filter is installed, the width of the receiver passband will be narrowed whenever the MODE selector is set to CW-N. Use the CW-W position to make stations easy to hear while you tune, and then switch to CW-N when the desired station is heard. Notice that the desired station may be lost unless it is first tuned to produce an audio tone close to 800 Hz (the frequency of the sidetone oscillator, heard on transmit). Tuning the received station for an 800 Hz tone ensures that, when transmitting, the signals will be on the same frequency.

When the CW-N position is selected interfering background stations and noise will be greatly reduced.

FM Reception (optional)

The only controls necessary for FM reception are the Tuning Knob, AF and SQL controls. The RF ATT button may still be helpful for very strong signals, and the FIX button may be used if the optional crystal is installed. All other controls are disabled. To adjust the SQL (squelch) control, tune to a clear frequency and adjust the control to the point where the noise just disappears. Now, when the transceiver is tuned to a station transmitting FM, the squelch will open and the station will be heard clearly.

FM stations may be found on HF generally above 29 MHz, or on the upper portions of the 50, 144 and 430 MHz bands (when using the FTV-700 V/UHF Transverter with the FT-77).

TRANSMITTING

The solid state transmitter in the FT-77 requires no tuning once the transmitting frequency has been selected. However, there are certain precautions that must be taken at all times to avoid damage to the transceiver.

Never transmit without having a dummy load, or antenna tuned to the operating frequency, connected to the transceiver. If there is any doubt about using a particular antenna at a certain frequency, check the SWR, as described on page 17.

When transmitting, never move the BAND or MODE selectors, as this will probably damage the selector and/or the final transistors.

When transmitting CW at full power, do not hold the key down continuously for more than 30 seconds. If it is necessary to transmit continuously for close to 30 seconds, let the transceiver cool in the receive state for at least 2 minutes before transmitting again. Output power will be automatically reduced if the temperature of the final transistors becomes too high.

Never transmit when using an antenna without first listening for a few minutes to make sure the frequency is clear. This will avoid accidental interference to other stations.

The FT-77 is equipped with a cooling fan inside of the heat sink, which will be activated automatically when the final transistors reach a certain temperature. Transmission may be continued, but power may decrease if the transmission is long. The fan will stop when the temperature of the finals drops.

SSB

Before transmitting, preset the BAND and MODE selectors to the desired operating band and sideband (USB above 10 MHz, or LSB). Open the top access panel and set the ALC-REF-FWD switch to ALC. Also preset the MIC/DRIVE control to midrange, and tune to the desired operating frequency. For proper results, a 50-ohm dummy load or antenna tuned for the operating frequency must be connected.

If using an antenna, first listen to make sure that the frequency is not already occupied, and then press the PTT (push-to-talk) switch on the microphone. The Meter, indicating ALC, should not deflect until the operator speaks.

While speaking into the microphone, adjust the MIC/DRIVE control, if necessary, so that the ALC deflection on the Meter remains just within the ALC zone at the left half of the scale (corresponding to the blue zone on the lower SWR scale). If the ALC indication is erratic and cannot be adjusted properly, check the SWR as described on the next page. During transmission, periodically check the ALC indication to make sure that the Meter is not deflecting into the RED zone on voice peaks.* If it does, simply readjust the MIC/DRIVE control. Intentionally setting the MIC/DRIVE control higher will not increase power output, but may cause distortion of the transmitted signal, as well as illegal spurious radiation. Be careful.

CW

Connect the key or electronic keyer output line to the KEY jack on the rear panel. Set the MODE selector to CW-W or CW-N, and select the BAND and operating frequency desired. Preset the MIC/DRIVE control to midrange, and make sure that a dummy load or proper antenna is connected to the ANT jack. Preset the ALC-REF-FWD switch under the access panel to the ALC position.

If using an antenna, check first to make sure the frequency is clear, and then close the key. Adjust the MIC/DRIVE control, if necessary, to the point where the ALC indication on the Meter is just at the upper edge of the ALC zone, but not into the RED zone*. This setting indicates full power CW. If it is not possible to obtain this reading, check the SWR as described on the next page.

* For lower power operation the MIC/DRIVE control may be set for any level where the ALC indication is lower . . . an excellent practice after making contact with another station, whenever the signal is strong enough. This will lengthen the life of the equipment as well as minimize possible interference to others.

The SIDE TONE control under the access panel can be adjusted for the desired volume of the sidetone signal when the key is closed.

The transmit-to-receive switching time for CW operation can be adjusted by the DELAY control under the access panel. The proper setting will depend on the CW speed of the operator, and on personal preference for semi break-in operation. Of course the PTT switch on the microphone may be used for transmit/receive switching instead, or a footswitch can be connected between ground and pin 6 of the ACC-1 jack (or pin 3 of the ACC-2 jack) on the rear panel for PTT control.

FM (requires optional FM Unit)

Please review the paragraphs on FM reception. Power output during FM transmission must be limited to about 50 watts, because of the semi-continuous duty cycle which would cause rapid overheating of the final transistors if driven for higher power. Of course this limitation does not apply when the FT-77 is used with a VHF/UHF transverter, but for FM transmission in the 28–29.7 MHz range, please limit the output power as described here.

After setting the BAND and MODE selectors to the proper positions, preset the ALC-REF-FWD switch to ALC, and the MIC/DRIVE control to about midrange. Make sure that a dummy load or properly matched antenna is connected to the ANT jack.

If using an antenna, first listen to make sure the frequency is clear, then press the PTT switch on the microphone and adjust the MIC/DRIVE control, if necessary, to obtain an ALC indication in the middle of the ALC zone (corresponding with the blue SWR zone). Release the PTT switch.



Now move the ALC-REF-FWD switch to FWD, press the PTT switch, and adjust the FWD SET control (also under the access panel) to obtain a Meter indication exactly at the right edge of the Meter scale (SET mark). Finally, rotate the MIC/DRIVE control counterclockwise until the Meter indicates "8" on the PO scale. Release the PTT switch.

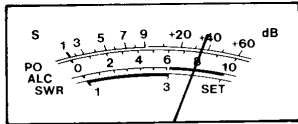

The FT-77 is now set for 50 watts FM output. Note the exact position of the MIC/DRIVE control for future operation in the same frequency range with the same antenna. The PO Meter indication should be "8" or less as long as the FWD SET control is not readjusted; otherwise the above procedure will need to be repeated.

If an external wattmeter is used with the FT-77, simply set the MIC/DRIVE control for 50 watts on the wattmeter. The rest of the procedure is then not required.

CHECKING AND MEASURING SWR

These procedures allow checking and measurement of the relative amount of power being applied to the load (connected to the antenna jack), versus the amount being reflected back to the transmitter. A properly matched antenna system will have little or no reflected power, even when full transmitting power is applied. The first procedure is for checking SWR when the quality of the load (antenna plus feedline) is unknown or in doubt for use at a particular frequency. The second procedure may be used when the quality of the load SWR is known to be close to 50 ohms, and a more accurate measurement is desired. Each requires that either a microphone or a straight CW key be connected. If using an electronic keyer that does not permit constant key-down, it should be unplugged.

SWR Check

Under the access panel, preset the ALC-REF-FWD switch to the FWD position, and rotate the FWD SET control fully clockwise. Set the MODE selector to a CW position, and tune the transceiver to the frequency at which the SWR is to be checked. (The SWR will be generally different for different frequencies, unless the load is a dummy load.) Reduce the MIC/DRIVE control to the fully counterclockwise position.

Wait to make sure that the frequency is clear of traffic, and then press the PTT switch on the microphone and/or close the key, if connected. Gradually advance the MIC/DRIVE control until the Meter deflects just to the right edge of the scale (SET mark). Now move the ALC-REF-FWD switch to the REF (center) position, and note the Meter indication. Release the PTT switch or key.

If the Meter indicated to the right of the blue zone on the lower Meter scale (SWR), the antenna system is not properly matched to the transceiver for operation on the test frequency. This procedure only applies about five to ten watts to the antenna system, so it would not damage the transceiver, but high power transmission must be avoided at this frequency into this load.

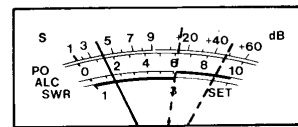

SWR indications around the right end of the blue zone (marked "3") indicate poor antenna matching. However, an antenna tuner such as the FC-700 can be used to tune the antenna system to provide the proper match. Of course, this will not improve the quality of the antenna system itself, so it is better to correct the antenna or feedline mismatch first, if possible.

Little or no deflection of the Meter indicates a matched antenna system for use at this frequency. Perform the following procedure for an accurate measurement at full power if the REF indication was low.

SWR Measurement

If the quality of the load (antenna plus feedline) is unknown or in doubt for the test frequency, perform the preceding SWR Check first.

Under the access panel, preset the ALC-REF-FWD switch to ALC. Before transmitting, set the MODE selector to a CW position, and tune the transceiver to the frequency at which the SWR is to be measured. During the following steps, do not hold the transmitter keyed for more than 30 seconds.

Wait to make sure that the frequency is clear of traffic, and then press the PTT switch on the microphone and/or close the key, if connected. Adjust the MIC/DRIVE control to obtain a Meter indication in the middle of the ALC zone (also the middle of the blue SWR zone), and return to receive.

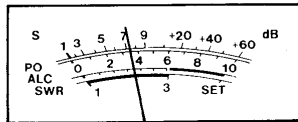

Move the ALC-REF-FWD switch to the FWD position, and adjust the FWD SET control (also under the access panel) while again keying the transmitter, to obtain a Meter deflection just exactly to the right edge of the Meter scale (SET mark). Now move the ALC-REF-FWD switch to the REF (center) position, and note any Meter deflection. Return to receive.

If the Meter indicated to the right of the blue zone on the lower Meter scale (SWR), the antenna system is too far from the required 50-ohm impedance to be used at this frequency.

If the Meter indicated around the right end of the blue SWR scale (marked "3"), a poor match is present. Power output with an SWR of 3 is about 75% of full power, decreasing rapidly for higher SWR indications. An antenna tuner may be used to match the antenna system more closely, thus providing more power at this frequency.

No SWR Meter deflection indicates a 1:1 SWR, and full power will be delivered to the load. Notice that this will only occur at the frequency(ies) where the antenna system is perfectly matched.

FIXed Frequency Operation (requires optional crystal)

By installing an optional crystal in the FIX socket beneath the top access panel, the operating frequency of the FT-77 will be fixed whenever the FIX button on the front panel is pressed.

One crystal will produce a fixed frequency on each band of the transceiver, and thus only the kilohertz digits are fixed. However, the kilohertz digits will not be the same for all bands. For example, if 21.2500 MHz is fixed in the USB mode, the fixed operating frequency in the 10, 14, 18, 21, 28.0 and 29.0 MHz bands will be xx.2500 MHz. In the 24.5, 28.5 and 29.5 MHz bands the fixed frequency will be xx.7500 MHz (because of the automatic 500 kHz offset for these three bands). In the 7 MHz band the fixed frequency will be 7.2470 MHz (because the transceiver automatically offsets the USB mode from the LSB mode by 3 kHz to follow the natural carrier offset). In the 3.5 MHz band the fixed frequency will be 3.7470 MHz, because of the combination of the above two reasons (plus 500 and minus 3 kHz).

To determine the correct crystal frequency (F_x) that will provide the desired fixed operating frequency (F_o) for a certain mode, use the following formula:

$$F_x = F_L - F_o$$

where F_L is the frequency of the local oscillator for the desired operating band, listed in the Table below.

BAND \ MODE	U.S.B	L.S.B	CW, FM
3.5MHz	8995.5	8998.5	8996.2
7.0MHz	12495.5	12498.5	12496.2
10.0MHz	15498.5	15501.5	15499.2
14.0MHz	19498.5	19501.5	19499.2
18.0MHz	23498.5	23501.5	23499.2
21.0MHz	26498.5	26501.5	26499.2
24.5MHz	29998.5	30001.5	29999.2
28.0MHz	33498.5	33501.5	33499.2
28.5MHz	33998.5	34001.5	33999.2
29.0MHz	34498.5	34501.5	34499.2
29.5MHz	34998.5	35001.5	34999.2

FL(kHz)

The other requirements for the crystal are as follows:

Holder type:	HC-25/U
Load Capacitance:	30 pF
Equiv. Series Resistance:	25 ohms (maximum)
Shunt Capacitance:	7 pF (maximum)
Drive Level	5 mW

Notice that all crystals, regardless of intended operating frequency, will be between 5.0 and 5.5 MHz, since this is the range of the VFO.

Once the proper crystal has been selected and installed, depress the FIX button on the front panel and adjust the F.ADJ control under the access panel to "trim" the crystal oscillator to the precise frequency as displayed (make sure that the MODE selector is set to the intended operating mode first).

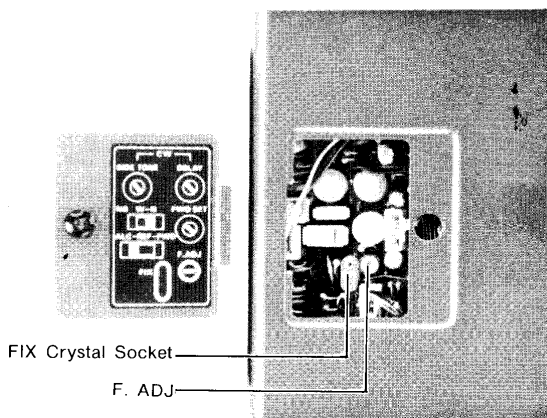

Marker Calibration (optional unit required)

For highly accurate frequency determinations, the optional crystal Marker Unit can be installed. Then by pressing the MARK button on the transceiver, a marker signal will appear at each multiple of 25 kHz throughout the frequency range of the transceiver.

To calibrate the Marker itself, let the transceiver, with antenna connected, warm up for at least 30 minutes. Then set the MODE selector to either USB or LSB, and tune the dial to zero beat with the time and frequency standard station (WWV or similar) at 10 MHz. Press the MARK button and adjust the trimmer capacitor on the Marker Unit, if necessary, to zero beat the Marker signal. In performing this calibration, make sure that the MARK button is off (out) when tuning the dial to 10 MHz, and do not touch the dial once the MARK button has been switched on (or it will not be possible to obtain the necessary zero beat).

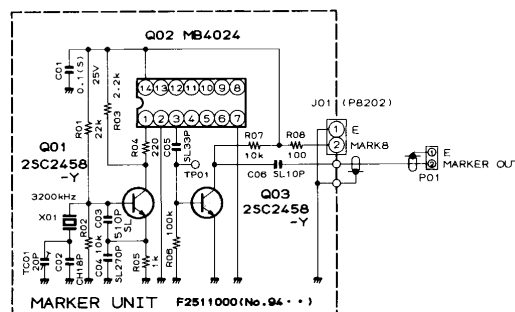
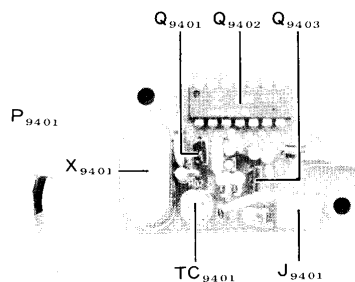

CAPACITOR VALUES ARE IN μ F, 50V, UNLESS OTHERWISE NOTED
 (S) CAPACITORS ARE SEMICONDUCTOR CERAMIC, 25V

INSTALLATION OF OPTIONS

CW Narrow Filter Installation

(Filter XF-8.9KC, Kit number D2000019)

1. Place the transceiver upside down on the work surface. Remove the nine screws affixing the bottom cover, and remove the cover.
2. Referring to the diagram below, locate the IF Unit, and remove the four screws (★) holding it in place.
3. Stand the transceiver on its side so that the IF Unit is uppermost, and gently pull the top edge of the IF Unit out just enough to allow space for soldering the filter terminals. Install the filter from the component side, and solder the filter terminals while making sure that the filter remains snugly seated on the board.
4. Return the transceiver to the upside down position, and locate jumper plug P₂₀₀₁. Remove this plug from J₂₀₁₅ and install it in J₂₀₁₄. (Do not move this plug to J₂₀₁₄ unless the narrow CW filter is installed.)
5. Replace the IF Unit and its four screws, making sure that no wires are pinched, and then replace the bottom cover and its nine screws.

Downloaded by

Amateur Radio Directory

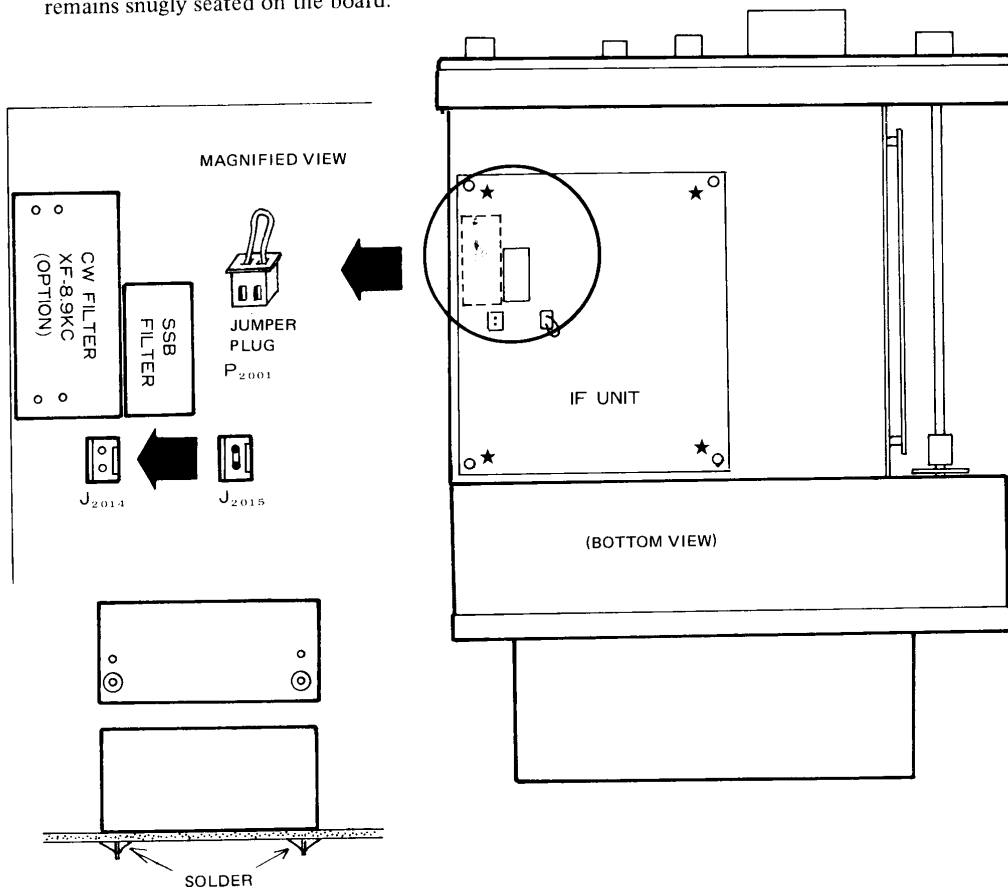

FM Unit Installation

Requires:

Kit number D3000233, consisting of:

- One FM Unit circuit board assembly C025120A
- One cable and connector assembly T9204593
- One cable and connector assembly T9204594
- Two self-tapping screws for mounting

Note: The connector plugs on the cable assemblies are marked with two numbers which correspond to the last two digits of the circuit part number; for example, P₉₅₀₁ is marked 01.

1. Remove the eight screws affixing the top cover, and remove the cover carefully; disconnecting the speaker leads before pulling the cover away.

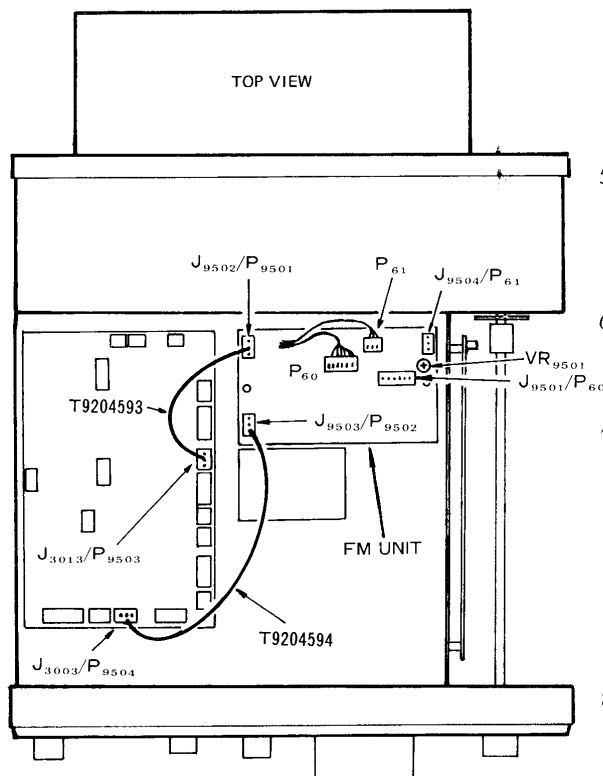

2. Referring to the diagram below, locate the correct position for mounting the FM Unit; in particular, notice the location of Jack J₉₅₀₃. With this positioned as shown in the diagram, affix the FM Unit in place with the self-tapping screws provided, while making sure that no wires or connectors are trapped beneath the Unit.

3. Locate 6-pin Plug P₆₀ and 3-pin plug P₆₁ in the transceiver, and connect them to J₉₅₀₁ and J₉₅₀₄ on the FM Unit, respectively, as shown in the diagram.

4. Connect the cable assembly connector plugs to the jacks on the AF Unit and FM Unit as follows:

Connect P₉₅₀₃ to J₃₀₁₃ on the AF Unit
 Connect P₉₅₀₁ to J₉₅₀₂ on the FM Unit
 Connect P₉₅₀₄ to J₃₀₀₃ on the AF Unit
 Connect P₉₅₀₂ to J₉₅₀₃ on the FM Unit

Double check these connections and compare with those shown in the diagram. Also note the routing of the two new cables shown in the drawing, and route these in the same way.

5. This completes the installation, place the top cover near the transceiver and reconnect the speaker wires. Connect the power source, and switch the transceiver on.
6. With no antenna connected, set the MODE selector to FM, and preset the SQL control to the 1 o'clock position.
7. Referring to the figure at the left, locate VR₉₅₀₁, and carefully adjust it to the squelch threshold point where receiver noise is just silenced. Do not adjust any other components on the FM unit, as it was carefully aligned at the factory. However, should realignment be required, refer to page 38 of the Instruction Manual.
8. Replace the top cover and its eight screws.

Marker Unit Installation

Requires:

One Marker Unit kit number D3000234, composed of:

- One Marker Unit number C025110A
- Two self-tapping screws

1. Remove the eight screws affixing the top cover, and remove the cover carefully; disconnecting the speaker leads before pulling the cover away.
2. Referring to the diagram below, mount the Marker Unit using the two screws supplied, noting in particular the location of J₉₄₀₁, which should be nearest the front panel. Use care not to trap any wires or connectors under the Unit.
3. Connect P₈₀₀₂ in the transceiver to J₉₄₀₁ on the Marker Unit.

4. Referring to the drawings below, route the output cable exactly as shown. Notice that this cable must be routed over the top of the FM Unit, if installed. Connect P₉₄₀₁ on the end of this cable to J₁₀₀₁ on the RF Unit (mounted vertically at the right side of the chassis).
5. Check and align the Marker Unit as described on page 19.
6. Reconnect the speaker wires and replace the top cover and its eight screws. Installation is now complete.

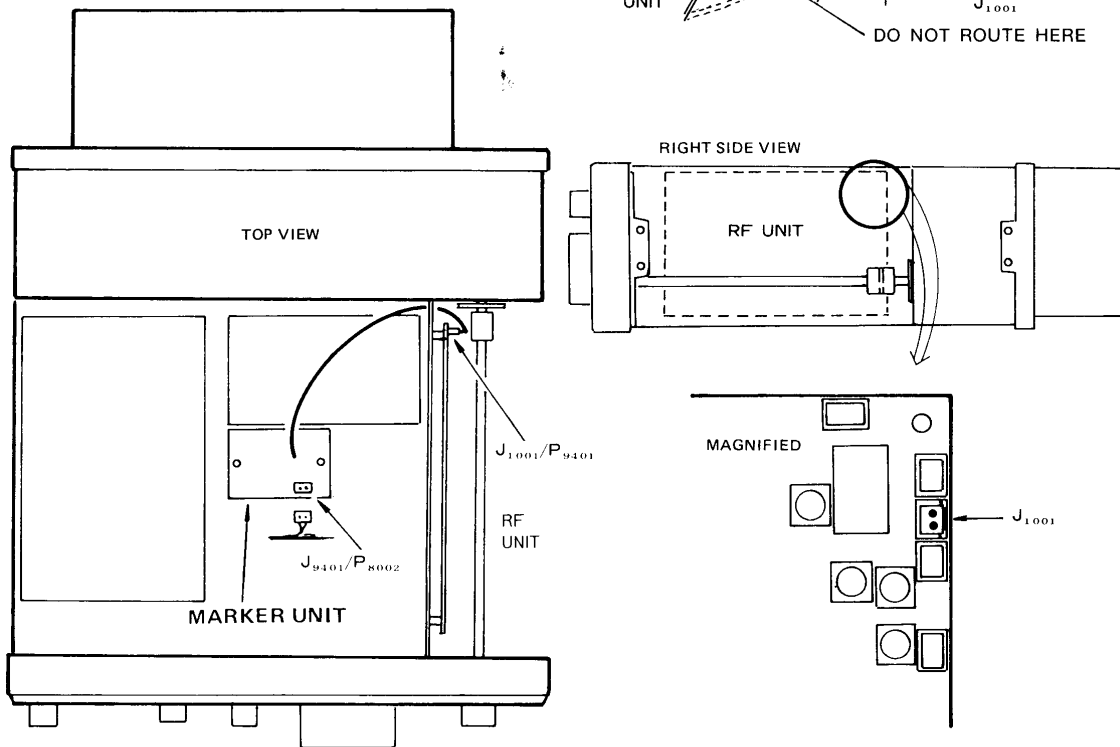

MMB-16 MOBILE MOUNTING BRACKET

The MMB-16 is designed to permit simple, convenient mobile installation of Yaesu compact HF mobile transceivers and accessory equipment. When used with the FT-77 Transceiver, the matching FV-700DM or FV-707DM External VFOs and FC-700 or FC-707 Antenna Tuners may also be installed.

1. Note that the transceiver and accessories have three mounting holes in each side, only two of which are used for mobile mounting. Select which two holes to use according to the desired distance that the equipment is to project forward of the bracket in the final mounting position.
2. If installing the transceiver with accessories, preassemble the slotted mounting brackets to the side plates using the four small screws. If installing the transceiver only, the mounting brackets are not needed.
3. If installing the transceiver with accessories, stack the equipment in the desired order and bolt the side plate/bracket assemblies to the equipment.
4. Temporarily bolt the main mounting plate to the side plates, and determine the proper mounting location in the vehicle. This must allow for several inches of clearance around the heat sink, and sufficient clearance for all cables (front and rear) and controls. In general, all of the equipment is designed to function properly regardless of the mounting position, but it should not be mounted directly in the path of the vehicle heater vents, nor where it could interfere with driver vision or vehicle operation.
5. Now remove the main mounting plate, and use it as a template to locate the mounting holes on the vehicle. Use a 3/16 inch (4.8 mm) bit for drilling the holes.
6. Affix the main mounting plate to the vehicle as shown in the diagram, and then finally affix the side plates, with the equipment affixed, to the main mounting plate. Notice that there are three possible positions for the rear bolt, allowing several choices of mounting angle.

If installing the transceiver only, bolt the side plates to the transceiver using the lower holes in the side plates.

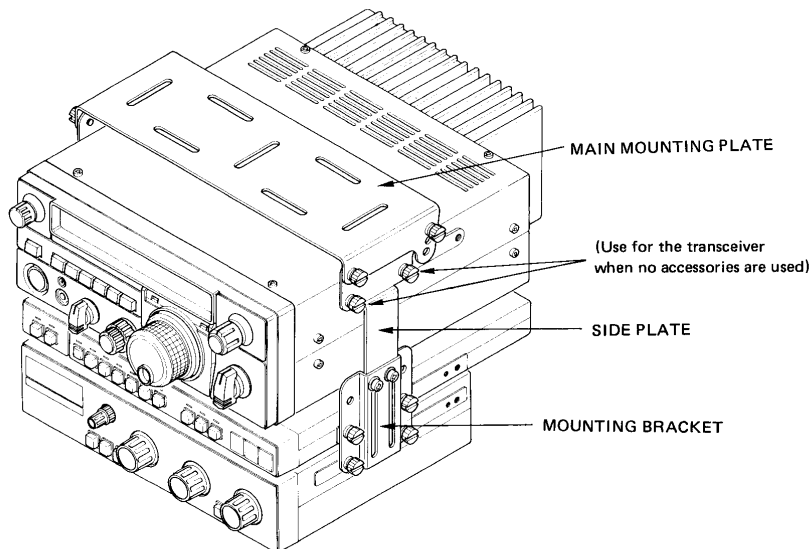

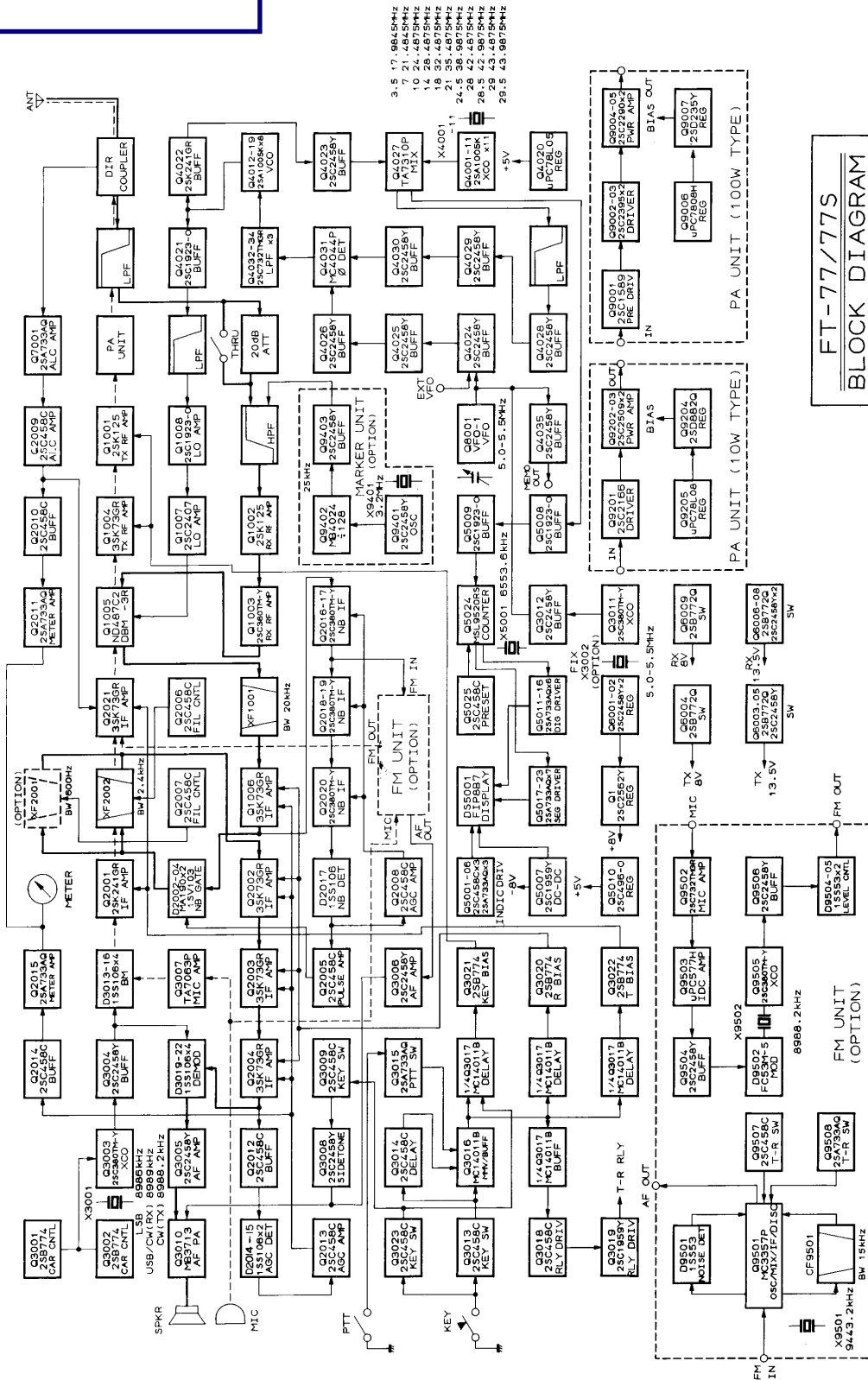

FT-77/77S
BLOCK DIAGRAM

CIRCUIT DESCRIPTION

The block diagram and following circuit description will provide a better understanding of the design and function of this transceiver. Refer to the schematic diagrams for specific component details.

RECEIVER

LPF Unit (F2509104)

The RF input signal from the coaxial antenna jack is fed to the LPF Unit, where it is passed through directional CM coupler T_{7001} to the rotary arm of bandswitch wafer (b) of S_{7001} , which is part of the ALC Unit. One of five lowpass filters is selected according to the bandswitch setting, and the filtered signal is then fed from wafer (a) of S_{7001} through T-R relay RL_{7001} , and delivered to the RF Unit.

RF Unit (F2509101)

The incoming signal is passed through lamp fuse PL_{1001} and attenuator relay RL_{1001} , and then along with the Marker signal (if installed and activated), through a highpass filter and diode switches to one of eight bandpass filters (selected by control signals from the bandswitch).

From the bandpass filter the signal is applied to RF amplifier Q_{1002} (2SK125), and from there through amplifier/buffer Q_{1003} (2SC380TM-Y) before additional filtering through one of another eight bandpass filters. From this second filter the signal is applied to ring mixer module Q_{1005} (ND487C2-3R), where it is mixed with the appropriate local signal. The local signal is delivered from the PLL Unit; filtered, and then amplified by Q_{1008} (2SC1923-O) and Q_{1007} (2SC2407) before application to the mixer.

The resulting 9 MHz mixer product is passed through crystal filter XF_{1001} (20 kHz bandwidth) to IF amplifier Q_{1006} (3SK73GR), and then delivered to the IF Unit.

IF Unit (F2510101)

A portion of the 9 MHz signal from the RF Unit is fed to the noise blanker circuit, consisting of noise amplifier pairs Q_{2016} , Q_{2017} and Q_{2018} , Q_{2019} (all 2SC380TM-Y), and then Q_{2020} (2SC380TM-Y). After amplification the noise is detected by D_{2017} (1SS106) a portion of the output of which is amplified by Q_{2008} (2SC458C) and applied to the noise amplifiers for AGC. The remainder of the detected noise from D_{2017} is applied to pulse amplifier Q_{2005} (2SC458C), which controls noise blanker gate D_{2002} – D_{2004} (MA190 x 2, and 1SV103). For FM reception, the signal is extracted after amplification by Q_{2016} and Q_{2017} , and delivered to the optional FM Unit (when installed).

The remainder of the 9 MHz signal from the RF Unit is applied directly to the noise blanker gate, and is passed through whenever a noise pulse has not switched the gate off. The signal is then passed through 8-pole monolithic crystal filter XF_{2002} (8F-2.4D, 2.4 kHz bandwidth), or though optional 8-pole narrow CW crystal filter XF_{2001} (XF8.9KC, 600 Hz bandwidth), when installed and selected by the mode switch. Q_{2007} (2SC458C) performs the necessary filter switching upon command from the MODE selector (when the optional filter is installed).

From the filter the signal is amplified by Q_{2002} , Q_{2003} and then Q_{2004} (all 3SK73GR) before delivery to the AF Unit for demodulation. A portion of the output of Q_{2004} is buffered by Q_{2012} (2SC458C) and the AGC is detected by D_{2014} and D_{2015} (1SS106). This DC voltage is amplified by Q_{2013} (2SC458C) and fed to IF amplifiers Q_{2002} , Q_{2003} and Q_{2004} , as well as to Q_{1006} on the RF Unit, to control the gain of these stages. A portion of the AGC voltage is buffered by Q_{2014} (2SC458C), and amplified by Q_{2015} (2SA733AQ) for delivery to the S-meter.

AF Unit (F2510102)

After final IF amplification by Q₂₀₀₄, the signal is delivered to ring demodulator D₃₀₁₉–D₃₀₂₂ (all **1SS106**) on the AF Unit. The demodulator also receives the carrier signal generated by carrier oscillator Q₃₀₀₃ (**2SC380TM-Y**) after buffering by Q₃₀₀₄ (**2SC2458Y**), the frequency of which is determined by crystal X₃₀₀₁ and carrier controller Q₃₀₀₂ (**2SB774**). Thus the carrier oscillator frequency is 8986 kHz for LSB, and 8989 kHz for USB and CW (receive).

The resulting audio product from the demodulator is amplified by Q₃₀₀₅ (**2SC2458Y**) and finally by AF power amplifier module Q₃₀₁₀ (**MB3713**) before delivery to the speaker or headphones.

FM Unit (F2512000, option)

The wideband IF signal extracted from the first noise blanker amplifiers on the IF Unit is delivered to Q₉₅₀₁ (**MC3357P**), which contains a local oscillator, mixer, IF amplifier, limiter and discriminator. Crystal X₉₅₀₁ sets the local oscillator to 9443.2 kHz, and the mixer within Q₉₅₀₁ thus produces an internal IF at 455 kHz. This is passed out through ceramic filter CF₉₅₀₁ (15 kHz bandwidth), and then back to a limiting amplifier in Q₉₅₀₁. The limiter amplifier delivers the signal to the discriminator, also within Q₉₅₀₁, which provides an audio output in response to changes in frequency of the input signal. This audio is delivered to the AF Unit, where it is amplified first by Q₃₀₀₆ (**2SC2458Y**) and then AF power amplifier module Q₃₀₁₀ for delivery to the speaker or headphones.

A portion of the audio output from the discriminator section of Q₉₅₀₁ is high-pass filtered and fed to noise detector D₉₅₀₁ (**1SS53**), and then back to Q₉₅₀₁ for amplification. When no carrier is present in the receiver passband a high level of high frequency noise appears at the discriminator output, and this is detected by D₉₅₀₁, the amplified output of which squelches off the audio output from Q₉₅₀₁ to the AF Unit.

Marker Unit (F2511000, option)

Crystal oscillator Q₉₄₀₁ (**2SC2458Y**) generates a 3200 kHz signal, which is divided by 128 at Q₉₄₀₂ (**MB4024**). The resulting 25 kHz square wave is buffered by Q₉₄₀₃ (**2SC2458Y**) and delivered to the receiver front end (just after the attenuator relay) on the RF Unit.

TRANSMITTER

The following transmitter section descriptions are organized according to mode.

SSB

Transmitter audio input from the microphone is passed through the MIC/DRIVE control to microphone amplifier Q₃₀₀₇ (**TA7063P**) on the AF Unit, and then applied to balanced ring modulator D₃₀₁₃–D₃₀₁₆ (all **1SS106**). The carrier signal from buffer Q₃₀₀₄ is also applied to the modulator, the frequency of which is shifted slightly for the selected sideband as described in the Receiver description.

The resulting double-sideband 9 MHz output from the modulator is delivered to the IF Unit, where it is amplified by Q₂₀₀₁ (**2SD241GR**) and then applied to SSB filter XF₂₀₀₂. The filter removes the unwanted sideband, and the remaining sideband is then amplified by Q₂₀₂₁ (**3SK73GR**) and delivered to the RF Unit.

On the RF Unit the signal is applied to ring mixer module Q₁₀₀₅, along with the local signal (described in the Receiver description and PLL Unit description to follow). The output of the mixer at the desired transmit frequency is passed through one of eight bandpass filters selected by control signals from the bandswitch, and then amplified further by Q₁₀₀₄ (**3SK73GR**). The signal is again filtered by one of another eight bandpass filters, and then amplified further by Q₁₀₀₁ (**2SK125**) before delivery to the PA Unit.

On the PA Unit (PB-2013B) the signal is amplified by predriver Q₉₀₀₁ (**2SC1589**), and drivers Q₉₀₀₂ and Q₉₀₀₃ (both **2SC2395**) before final amplification by Q₉₀₀₄ and Q₉₀₀₅ (both **2SC2290**). Bias current for the finals is derived from the TX13.5V line by Q₉₀₀₆ (**μPC7808H**) and Q₉₀₀₇ (**2SD235Y**).

After final amplification the transmit signal is delivered to the LPF Unit, where it passes through T-R relay RL₇₀₀₁ and then one of five lowpass filters selected by bandswitch wafers (a) and (b) of S₇₀₀₁ located on the LPF Unit. The signal then passes through the directional CM coupler, and to the antenna jack.

The CM coupler senses the level of the transmitted signal passing through to the antenna, and provides a low level RF voltage which is detected by D₇₀₀₅ (for forward power meter indication), D₇₀₀₆ (for reflected power meter indication), and D₇₀₀₇ and D₇₀₀₈ for ALC derivation. D₇₀₀₅–D₇₀₀₈ are all 1SS97. The rectified voltages from D₇₀₀₅ and D₇₀₀₆ are delivered to the ALC-REF-FWD switch on the AF Unit, and then to relay RL₂₀₀₁ on the IF Unit before delivery to the meter.

The DC voltage from D₇₀₀₇ and D₇₀₀₈ is amplified by Q₇₀₀₁ (2SA733AQ) and delivered to Q₂₀₀₉ (2SC458C) on the IF Unit for amplification. The amplified ALC voltage is then applied to transmitter IF amplifier Q₂₀₂₁ to control its gain, while a sample is buffered by Q₂₀₁₀ (2SC458C), amplified by Q₂₀₁₁ (2SA733AQ), and delivered to the ALC-REF-FWD switch on the AF Unit. When this switch is set to the ALC position, the ALC is delivered back through RL₂₀₀₁ on the IF Unit, and then to the meter.

CW

The keying signal applied to the KEY jack is delivered to key switches Q₃₀₁₃ and Q₃₀₂₃ (both 2SC458C) on the AF Unit. Q₃₀₁₃ passes part of its output to semi break-in delay switch Q₃₀₁₄ (2SC458C), the output of which is applied to monostable multivibrator Q₃₀₁₆ (MC14011B). The rest of the output from Q₃₀₁₃ is applied directly to Q₃₀₁₆. When the PTT line is not closed, Q₃₀₁₆ provides a switching output delayed according to the setting of the DELAY control, VR₃₀₀₃, on the AF Unit. When the PTT line is closed, PTT switch Q₃₀₁₅ (2SA733AQ) locks Q₃₀₁₆ on.

Output from Q₃₀₁₆ is applied to four quarters of Q₃₀₁₇ (MC14011B) for delay. One of these quarters also receives a portion of the switching output from Q₃₀₂₃, and the delayed output controls key bias switch Q₃₀₂₁ (2SB774), which in turn controls transmit RF amplifiers Q₁₀₀₁ and Q₁₀₀₄ on the RF Unit. Another quarter of Q₃₀₁₇ controls receive

bias switch Q₃₀₂₀ (2SB774), which in turn disables receive IF amplifiers Q₁₀₀₆ (on the RF Unit), and Q₂₀₀₂–Q₂₀₀₄ (on the IF Unit) during transmission. A third quarter of Q₃₀₁₇ controls transmit bias switch Q₃₀₂₂ (2SB774), which in turn enables transmit IF amplifiers Q₂₀₀₁ and Q₂₀₂₁ on the IF Unit. The remaining quarter of Q₃₀₁₇ buffers the keying signal for relay driver Q₃₀₁₈ (2SC458C), which then controls relay driver Q₃₀₁₉ (2SC1959Y) to operate T-R relays RL₂₀₀₁ on the IF Unit and RL₇₀₀₁ on the LPF Unit.

The output of keying switch Q₃₀₂₃ also controls switch Q₃₀₀₉ (2SC458C), which controls sidetone oscillator Q₃₀₀₈ (2SC2458Y) so that when the key is closed Q₃₀₀₈ passes an audio signal to audio amplifier Q₃₀₁₀.

The TX8V and CW8V lines are used to switch Q₃₀₀₁ (2SB774) in order to change the frequency of the carrier oscillator Q₃₀₀₃ 800 Hz; to 8988.2 kHz (during CW transmission only). This shift allows the carrier signal to pass through the selected IF filter, and compensates for the 800 Hz sidetone, so that the actual transmit frequency is the same as the receive frequency when the latter is tuned for the same pitch as the sidetone.

The MIC/DRIVE control sets the level of voltage applied to ring modulator D₃₀₁₃–D₃₀₁₆ to unbalance it and allow the carrier signal to pass to Q₂₀₀₁ on the IF Unit for amplification and eventual transmission in the same fashion as for SSB.

FM (option)

Audio input from the microphone is delivered via the AF Unit to amplifier Q₉₅₀₂ (2SC732TMGR) on the FM Unit, when installed. The speech signal is then fed to IDC (instantaneous deviation control) limiter amplifier Q₉₅₀₃ (μ PC577H), the output of which is buffered by Q₉₅₀₄ (2SC2458Y) and then applied to modulating varactor D₉₅₀₂ (FC53M-5). D₉₅₀₂ is part of the resonant circuit set by crystal X₉₅₀₂ so that Q₉₅₀₅ (2SC380TM-Y) oscillates with a center frequency of 8988.2 kHz, frequency modulated by the audio applied to D₉₅₀₂.

The output of Q₉₅₀₅ is buffered by Q₉₅₀₆ (2SC-2458Y), and then passed through D₉₅₀₄ and D₉₅₀₅ (both 1SS53), which also receive a level controlling voltage from the MIC/DRIVE control to adjust the FM drive level. The frequency modulated signal from D₉₅₀₅ is then delivered to transmit IF amplifier Q₂₀₂₁ (after the narrow filters) for further amplification and eventual transmission in the same fashion as the other modes.

COMMON CIRCUITS

PLL Unit (F2510103)

The PLL consists of a single loop for which one of eight VCOs and one of ten crystal reference oscillators are selected according to the setting of the BAND selector. The PLL is locked to the VFO, so that the oscillating frequency of the selected VCO is always the local frequency required to produce the 9 MHz IF frequency when mixed with the incoming receive frequency at mixer module Q₁₀₀₅ on the RF Unit (or to produce the correct transmit frequency from the 9 MHz IF).

A portion of the output from the selected VCO, one of Q₄₀₁₂–Q₄₀₁₉ (all 2SA1005K), is buffered by Q₄₀₂₂ (2SK241GR) and again by Q₄₀₂₃ (2SC-2458Y) before being fed to PLL mixer Q₄₀₂₇ (TA7310P). This mixer also receives the signal from the selected crystal reference oscillator, one of Q₄₀₀₁–Q₄₀₁₁ (all 2SA1005K) for the selected band.

The output of Q₄₀₂₇ is then lowpass filtered and buffered by Q₄₀₂₈, Q₄₀₂₉ and Q₄₀₃₀ (all 2SC2458Y) before being applied to phase detector Q₄₀₃₁ (MC4044P). The phase detector also receives a signal from either the internal VFO, external (accessory) VFO, or fixed frequency crystal option (if installed) all of which are first buffered by Q₄₀₂₄, Q₄₀₂₅ and Q₄₀₂₆ (all 2SC2458Y). (Before these buffers, Q₄₀₃₅ (2SC2458Y) is provided as a buffer for the external memory output line used by the FV-700DM External VFO, when connected.) When the optional FIX crystal is installed the FIX button activates fix oscillator Q₃₀₁₁ (2SC-380TM-Y) on the AF Unit, and its output is then buffered by Q₃₀₁₂ (2SC2458Y) before delivery to the PLL Unit.

The phase detector compares the phases of the two signals at its input, and responds with a pulsed

DC voltage at its output which is proportional to any difference in phase. This output is lowpass filtered by Q₄₀₃₂, Q₄₀₃₃ and Q₄₀₃₄ (all 2SC-732TMGR) and then applied to a varactor in the selected VCO, thus locking the VCO to the VFO.

The output of the VCO is buffered by Q₄₀₂₁ (2SC1923-O) and lowpass filtered before delivery to the RF Unit, where it is filtered again before amplification at Q₁₀₀₈ (2SC1923-O) and then Q₁₀₀₇ (2SC2407). The resulting local signal is applied to the mixer module, Q₁₀₀₆.

Q₄₀₂₀ (μ PC78L05) serves as a separate voltage regulator for the phase detector.

Display Unit (F2510104)

A sample of the PLL signal at mixer Q₄₀₂₇ is delivered to the Display Unit, where it is buffered by Q₅₀₀₈ and Q₅₀₀₉ (both 2SC1923-O) before being applied to LSI counter Q₅₀₂₄ (MSL9520RS). The counter has preset offsets for the different modes, controlled by the 8V lines for each mode, and switched by Q₅₀₂₅ (2SC458C) and D₅₀₀₇–D₅₀₁₂ (all MA190TR). The multiplexed output of Q₅₀₂₄ is applied to fluorescent display tube DS01 (FIP8B7) through digit drivers Q₅₀₁₁–Q₅₀₁₆, and segment drivers Q₅₀₁₇–Q₅₀₂₃ (all drivers 2SA733AQ).

Unlock switch Q₅₀₁₀ (2SC496-O) deactivates the counter and display whenever the PLL unlocks. Q₅₀₀₁–Q₅₀₀₃ (all 2SC458C) and Q₅₀₀₄–Q₅₀₀₆ (all 2SA733AQ) illuminate the VFO-A, VFO-B or “F” (fix) indicators in the display, according to which frequency source is selected. The negative supply voltage required by the display is derived from the 13.5V line by DC-DC converter oscillator Q₅₀₀₇ (2SC1959Y).

VFO Unit (PB-2348A)

The FT-77 VFO uses a single IC, Q₈₀₀₁ (VFO-1), made especially for Yaesu and including all necessary buffering and biasing components. Varactor D₈₀₀₁ provides for clarifier control. L₈₀₀₅ and L₈₀₀₆, together with their accompanying capacitors, filter the 5–5.5 MHz output, which is delivered to the PLL Unit.

Regulator Unit (F2509103)

Q₆₀₀₁, Q₆₀₀₂ (both 2SC2458Y) and Q₁ (2SC-2562Y, on the main chassis) comprise the regulator to provide the regulated 8 volts for the 8V line from the 13.5V supply. TX8V and RX8V are then supplied from this line.

Transmit/receive signal TRX from Q₃₀₁₆ on the AF Unit is delivered to the Regulator Unit to control switches Q₆₀₀₅ and Q₆₀₀₇ (both 2SC-2458Y), so that when the PTT line or key is closed these switches are turned on. Q₆₀₀₅ then switches on Q₃₀₀₃ (2SB772Q) to supply the TX13.5V line, and Q₆₀₀₄ (2SB772Q) to supply the TX8V line.

Q₆₀₀₇ switches Q₆₀₀₈ (2SC2458Y) off, which then switches off Q₆₀₀₆ and Q₆₀₀₉ (both 2SB772Q). Q₆₀₀₆ supplies the RX13.5V line, and Q₆₀₀₉ supplies the RX8V line.



Scan by Dan

OUTER COVER REMOVAL

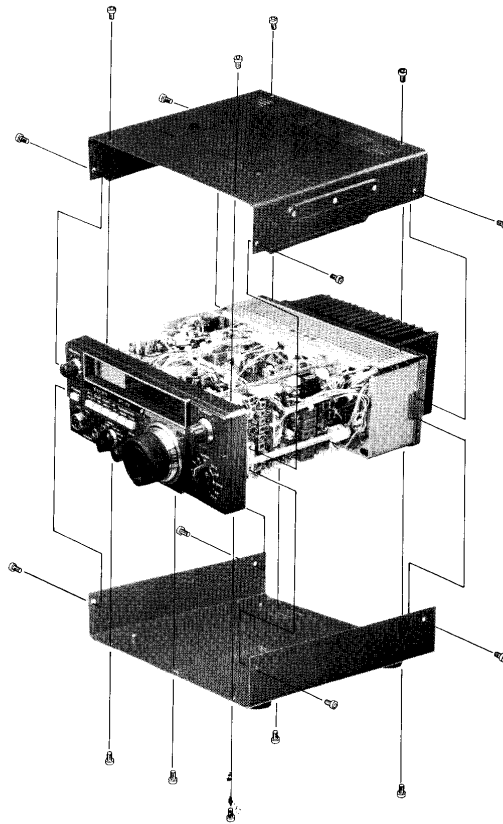

UNIT BOARD LAYOUT

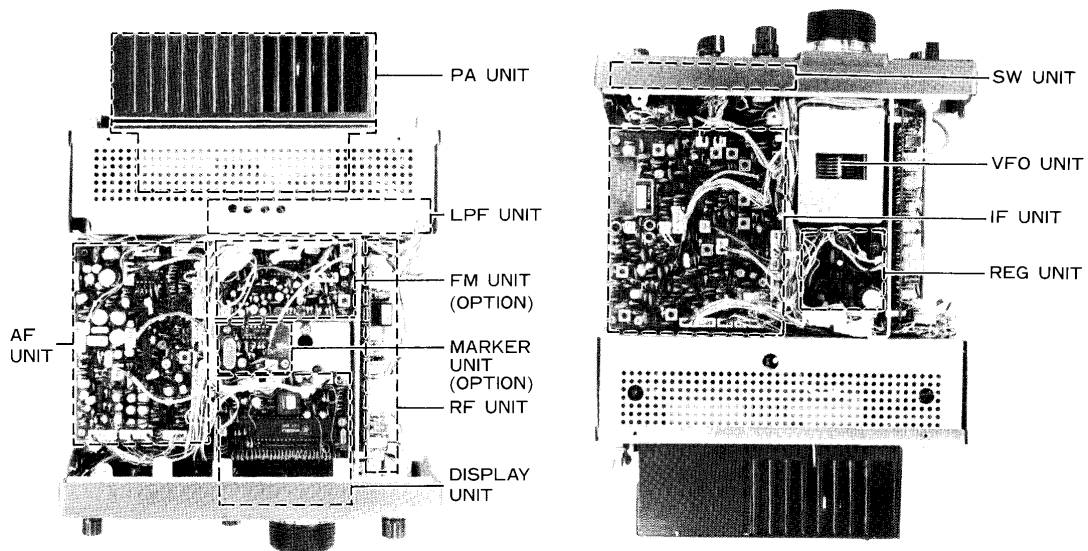

TOP VIEW

BOTTOM VIEW

ALIGNMENT

The FT-77 has been carefully aligned at the factory and under normal use should not require realignment beyond that which can be done with those controls accessible beneath the top access panel and described in the Operation Section of this manual. Additional realignment should not be attempted unless the internal operation of the transceiver is clearly understood, a malfunction is present and has been carefully analyzed, and the fault has definitely been traced to misalignment. Sudden operational failures are almost always caused by component failure, rather than misalignment.

Under no circumstances should any alignment be performed without the proper test equipment (see list). Before beginning alignment of a particular circuit, please read through the procedure, assemble the necessary test equipment and tools, and locate each test point and component referred to in the text.

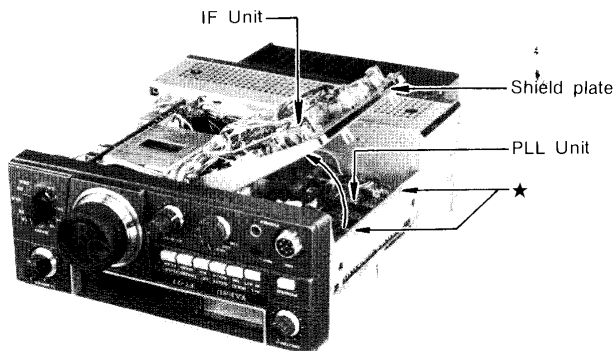

PLL Unit Access

1. With covers off, place the transceiver upside down and loosen the two screws marked "★".
2. Gently lift the outer edge of the shield plate (under the IF Unit).
3. Gently pry apart the front and rear chassis (slightly) while lifting the IF Unit free of the hinges. Lay the IF Unit upside down on the VFO as shown at the right.

TEST EQUIPMENT LIST:

- * One in-line wattmeter rated at 150W (Bird 43 or equivalent)
- * One 50-ohm, non-reactive dummy load (two required for SWR Protection Circuit Alignment)
- * Frequency counter accurate to 50 MHz (Yaesu YC-500E or equivalent)
- * Signal generator (Hewlett Packard HP 8640B or equivalent)
- * DC voltmeter (Hewlett Packard HP 4304B or equivalent)
- * VTVM or FETVOM with RF probe (Hewlett Packard HP 3406A or equivalent)
- * AF signal generator (HP 200CD or equivalent)
- * Sweep generator; for Bandpass Filter Alignment
- * Oscilloscope (Hewlett Packard HP1222A or equivalent)
- * FM Deviation Meter/SINADer; for FM Unit Alignment
- * External receiver tunable to 14.25 MHz; for Carrier Balance Alignment

Before beginning, remove the 17 screws affixing the top and bottom covers, and remove the covers. Turn on the transceiver and allow at least 30 minutes for it to stabilize.

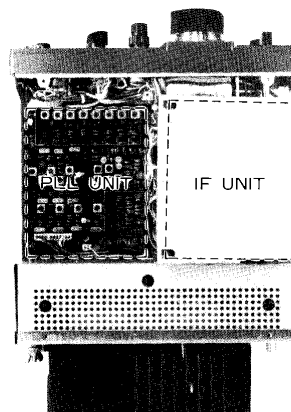

BOTTOM VIEW

COMMON CIRCUITS

PLL

This procedure requires adjustments in both the PLL and IF Units (part number formats AA400X and AA200X, respectively). Due to the interdependence of the PLL system, it is recommended that whenever alignment is required of any part in this system, the entire PLL alignment be performed.

PLL Local Oscillator Coils

1. Connector the RF probe of the VTVM to TP₄₀₀₃ on the PLL Unit.
2. Referring to the Table at the right, set the transceiver to each band and adjust the corresponding transformer for peak indication on the VTVM.

BAND	TRANSFORMER	ALIGNMENT FREQUENCY
3.5	T ₄₀₀₁	12.9845MHz
7.0	T ₄₀₀₂	16.4845MHz
10.0	T ₄₀₀₃	19.4875MHz
14.0	T ₄₀₀₄	23.4875MHz
18.0	T ₄₀₀₅	27.4875MHz
21.0	T ₄₀₀₆	30.4874MHz
24.5	T ₄₀₀₇	33.9875MHz
28.0	T ₄₀₀₈	37.4875MHz
28.5	T ₄₀₀₉	37.9875MHz
29.0	T ₄₀₁₀	38.4875MHz
29.5	T ₄₀₁₁	38.9875MHz

(PLL Local Oscillator Table)

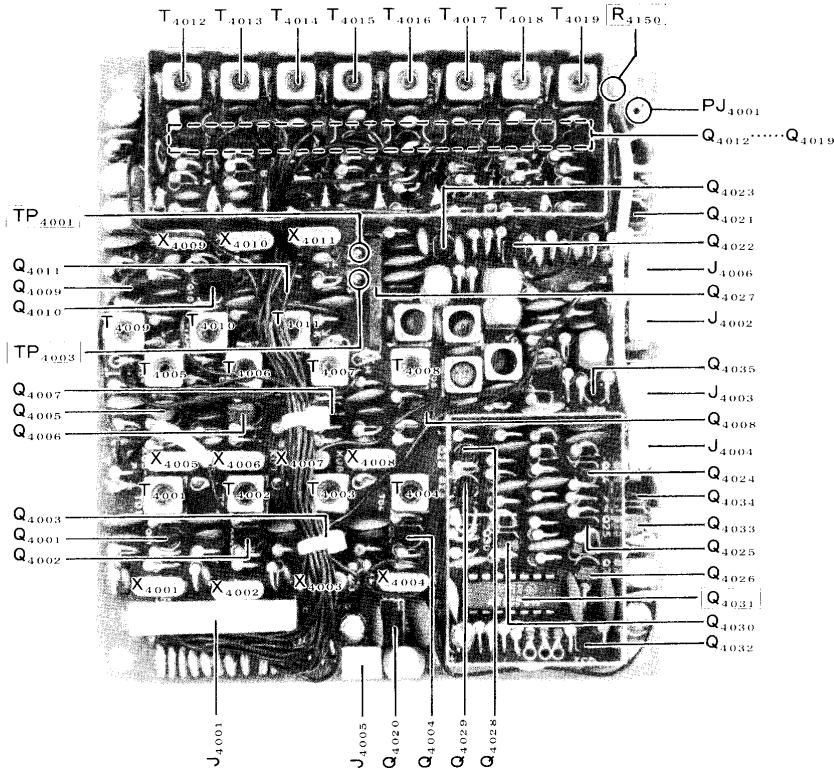

PLL UNIT

PLL Local Oscillator Frequency

1. Install a 5.000000 MHz crystal into the FIX socket (X₃₀₀₂), and connect the frequency counter to TP₃₀₀₂.
2. Adjust TC₃₀₀₅ for a reading of exactly 5 MHz on the counter, and then move the counter to TP₄₀₀₁.
3. Again referring to the previous Table, adjust each coil indicated on the appropriate band for the indicated frequency on the counter.
4. Connect the oscilloscope to pin 3 of Q₄₀₃₁ and check that the signal is at least 3V_{p-p}.

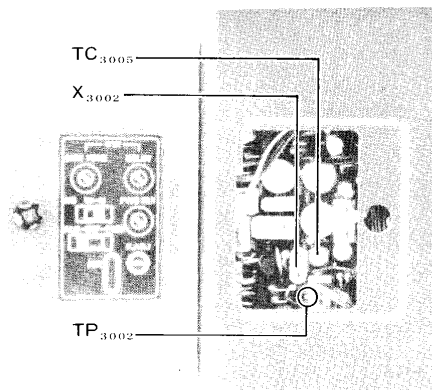

VCV (Varactor Control Voltage)

1. Connect the DC voltmeter between the hot side of R₄₁₅₀ and ground, set the VFO to the fully clockwise position (against the stop).
2. Referring the following Table, set the transceiver to each band and adjust the corresponding transformer for an indication of 6.5V on the voltmeter. (Note that the 28, 28.5 and 29 MHz bands are not included).
3. Now turn the VFO dial all the way to the lower stop, and again check the voltage for the level shown in the Table. For the 10 meter band, this time check only 28 MHz.

BAND	TRANSFORMER	ALIGNMENT V.	LOW END V.
3.5	T ₄₀₁₂	6.5V	2.2-3.5V
7.0	T ₄₀₁₃	"	"
10.0	T ₄₀₁₄	"	2.5-3.7V
14.0	T ₄₀₁₅	"	"
18.0	T ₄₀₁₆	"	2.6-3.8V
21.0	T ₄₀₁₇	"	2.2-3.5V
24.5	T ₄₀₁₈	"	2.8-4.0V
28.0	—	—	2.2-3.5V
29.5	T ₄₀₁₉	6.5V	—

Display Clock Oscillator

This procedure must be done only after the PLL Local Oscillator Frequency Alignment has been completed.

1. With a 5.000.000 MHz crystal installed in the FIX socket (X₃₀₀₂), set the BAND selector to 29.5 MHz, and the MODE selector to LSB.
2. Connect the frequency counter to TP₅₀₀₁ and check that the frequency at this point is 38.987.500 MHz. If not, adjust TC₃₀₀₅ to obtain this reading.
3. Adjust TC₅₀₀₁ for an indication of 30.000.5 MHz on the transceiver display.
4. Switch the MODE selector to USB and CW, checking for 29.998.5 and 29.999.3 on the display, respectively.

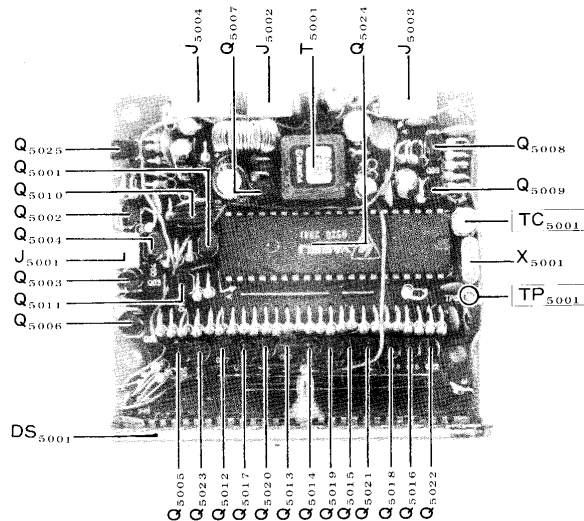

Downloaded by

 Amateur Radio Directory

RECEIVER

S-Meter Sensitivity

1. Tune the transceiver to 7.250.0 MHz, LSB mode, and connect the SSG (standard signal generator) to the ANT jack.
2. Without signal input from the SSG, preset VR₂₀₀₃ on the IF Unit for S-3 indication on the meter (no signal).
3. Set the SSG output to the receiver frequency at a level of 0 dB (ref. to 1 μV), and adjust VR₂₀₀₁ to reduce the S-meter deflection to the threshold point at which the meter just begins to deflect.
4. Increase the SSG output level to 6 dB and again adjust VR₂₀₀₃, for a reading of S-1.
5. Increase the SSG output level to 100 dB and adjust VR₂₀₀₄ so that the S-meter indicates exactly full scale.

Noise Blanker

1. Connect the DC voltmeter (10V range) between TP₂₀₀₂ on the IF Unit, and ground.

2. With the same equipment setup as in the S-Meter Sensitivity procedure, reduce the SSG level until the DC voltage just begins to decrease.
3. Adjust T₂₀₀₇, T₂₀₀₈ and T₂₀₀₉ for minimum indication on the voltmeter.

Clarifier

1. Depress the CLAR button (on), and set the CLARIFIER control exactly to the 12 o'clock position. Tune the transceiver to zero beat with the SSG or Marker signal.
2. Now switch the CLAR button off (out), and adjust VR₂₀₀₅ so that the signal is again zero beat.

IF Trap Coil

1. Tune the transceiver to 10.125.0 MHz, USB mode.
2. With the SSG connected to the ANT jack, set for an output level of 100 dB at 8.987.5 MHz.

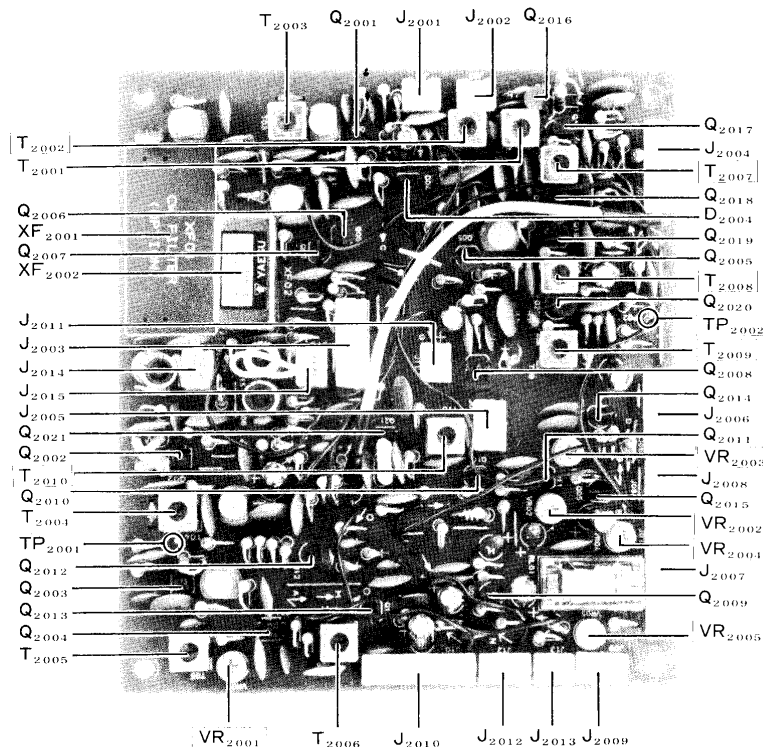

IF UNIT

- Adjust T_{1001} (on the RF Unit) for minimum deflection on the S-meter, or for minimum heterodyne level if the meter does not deflect.

RF Bandpass Filters

- Connect the sweep generator through a 5-kilohm resistor to TP_{1001} , and the detector of the sweep scope to pin 1 of J_{1004} .
- Remove P_{47} from PJ_{1001} to avoid misalignment during this procedure.
- Set the MODE selector to USB, and adjust both cores of each transformer as shown in the following Table for the passband shown in the figure (ripple within the passband should be less than 1 dB).

BAND	TRANSFORMER	ALIGNMENT PASSBAND
3.5	T_{1003}	3.5— 4.0MHz
7.0	T_{1004}	7.0— 7.5MHz
10.0	T_{1005}	10.0—11.0MHz
14.0	T_{1006}	13.9—14.6MHz
18.0	T_{1007}	17.9—18.5MHz
21.0	T_{1008}	21.0—21.5MHz
24.5	T_{1009}	24.5—25.0MHz
29.0	T_{1010}	28.0—30.0MHz

Bandpass Coil Table

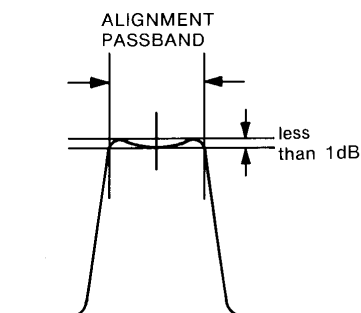

Passband Illustration

TRANSMITTER

Note: Connect the in-line wattmeter and 50-ohm dummy load to the ANT jack before proceeding with transmitter alignment. Do not switch bands or modes while transmitting. The PTT line can be closed by grounding pin 6 of either the MIC jack or the ACC-1 jack, or pin 3 of the ACC-2 jack. Transmitter audio input can be applied to the center pin (pin 8) of the MIC jack.

SSB Carrier Point

- Tune the transceiver to 14.250 MHz, LSB mode, and connect the AF signal generator to pin 8 of the MIC jack. Set the AF generator output to 1.5 kHz at about 5 mV.
- Close the PTT line and adjust the MIC/DRIVE control for 60W output on the wattmeter.
- Tune the AF generator to 300 Hz while maintaining exactly the same output level, and adjust TC_{3001} on the AF Unit for 15W output on the wattmeter.
- Return to receive and switch to the USB mode. Then repeat steps 1 through 3, adjusting TC_{3002} .
- In the receive mode, listen to the noise from the receiver while switching from USB to LSB and back several times. The pitch of the noise should be about the same.

CW Carrier Point

- Connect the frequency counter to TP_{3001} , close the PTT line, and adjust TC_{3003} for a reading of exactly 8988.200 kHz on the counter.

Carrier Balance

- With the transceiver tuned to 14.250.0 MHz, USB or LSB mode, set the external receiver to the same frequency. Set the MIC/DRIVE control fully counterclockwise.
- Close the PTT line and adjust VR_{3001} and TC_{3004} for minimum signal strength indication on the external receiver.
- Return to receive and switch to the opposite sideband (USB→LSB or LSB→USB).
- Repeat steps 2 and 3 several times to obtain the best null in both sidebands.

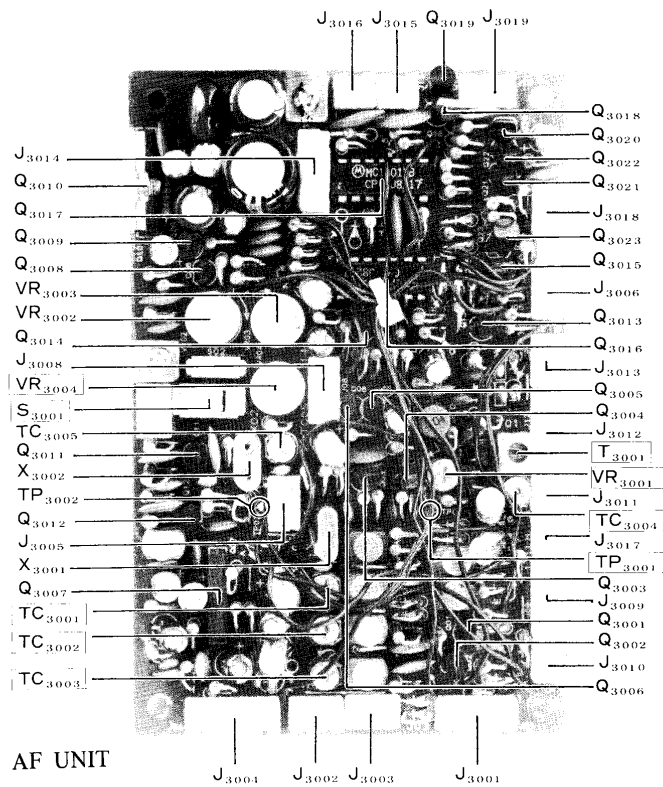
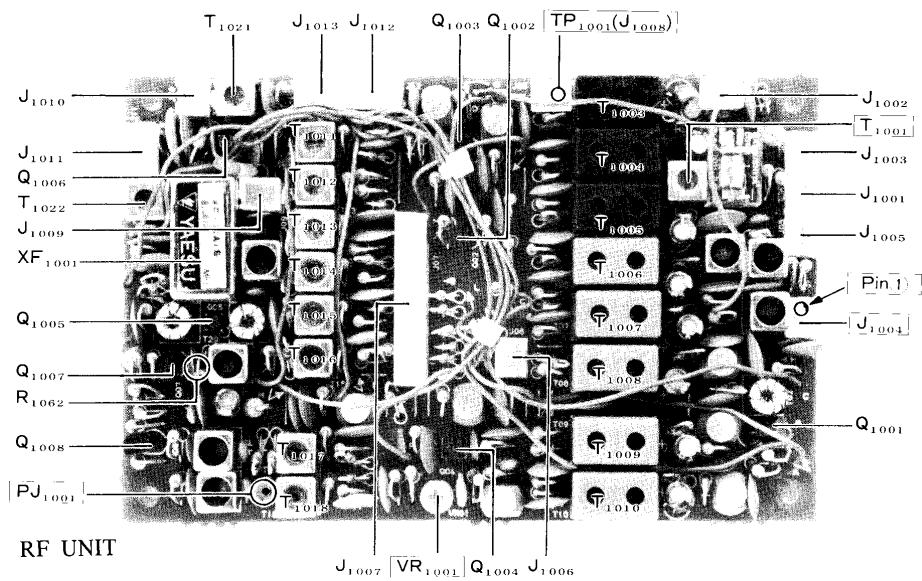

TX Coils

1. Set S_{3001} (ALC-REF-FWD) to the ALC position, and for each band, adjust the MIC/DRIVE control so that there is no deflection of the meter during the following step.
DO NOT CHANGE BANDS WHILE TRANSMITTING.
2. Referring to the following Table, adjust each transformer while transmitting on the corresponding band and frequency for maximum power output on the wattmeter.

BAND	TRANSFORMER	ALIGNMENT FREQUENCY
3.5	T_{1011}, T_{1022}	3.750MHz
7.0	T_{1012}	7.250MHz
10.0	T_{1013}	10.250MHz
14.0	T_{1014}	14.250MHz
18.0	T_{1015}	18.250MHz
21.0	T_{1016}	21.250MHz
24.5	T_{1017}	24.750MHz
29.0	T_{1018}	29.250MHz

3. Tune the transceiver to 14.250.0 MHz CW mode, and adjust T_{3001} , T_{2010} and T_{2002} for maximum power output on the wattmeter. (T_{2002} is also part of the receiver circuit, but should be peaked while transmitting.)

ALC Level

1. Tune the transceiver to 21.225.0 MHz, CW mode.
2. Close the PTT line and adjust VR_{7002} for 100W output on the wattmeter or 85W on 10 m. (VR_{7001} is an independent output limiting adjustment for the 10 meter band only. If for some reason power output on 10 meter should be set below 85W; adjust VR_{7001} accordingly.)

SWR Protection

1. Tune the transceiver to 3.750.0 MHz, LSB mode. Connect a 100-ohm non-reactive dummy load (or two 50-ohm units in series) to the ANT jack, and connect the AF generator to the MIC jack (pin 8). Set the generator for 5 mV output at 1 kHz.
2. Close the PTT line and adjust the MIC/DRIVE control so that the ALC meter indicates at the center of the ALC zone.
3. Adjust VR_{7003} to the threshold point where the ALC indication just begins to rise.

ALC Meter

1. Tune the transceiver to 21.225.0 MHz, USB mode. With the AF generator connected as in the previous procedure, reconnect one 50-ohm dummy load to the ANT jack.
2. Close the PTT line and adjust the MIC/DRIVE control to the threshold point just before the ALC meter begins to deflect.
3. Now increase the AF generator output level to 15 mV_{RMS}, and adjust VR_{2002} so that the ALC meter deflects just to the right edge of the ALC zone.

ALC Threshold

1. With the transceiver tuned to 21.255.0 MHz, USB mode, set the MIC/DRIVE control to the fully clockwise position.
2. Set the AF generator (connected to the MIC jack) for 0.5 mV_{RMS} at 1 kHz, and adjust VR_{1001} just to the threshold point where the ALC meter starts to deflect.

CM Coupler Balance and PO Meter FWD Preset

1. With the transceiver tuned to the 21 MHz band, USB mode; and the AF generator connected to the MIC jack, adjust the generator output to 5 mV_{RMS} at 1 kHz.
2. Adjust FWD SET potentiometer VR_{3004} fully clockwise. Close the PTT line and adjust the MIC/DRIVE control so that the ALC meter indicates to the point corresponding with the S-7 point on the S-meter scale.
3. Set S_{3001} to the REF position and adjust TC_{7001} to obtain a null (zero) on the meter.
4. Now set S_{3001} to the FWD position and adjust VR_{3004} for full scale deflection on the meter.

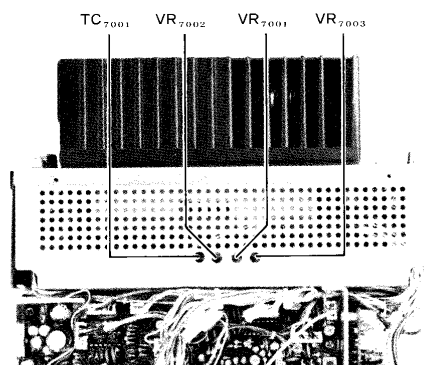

TOP VIEW

FM UNIT (if installed)

Discriminator

1. Tune the transceiver to 29.250.0 MHz, FM mode. Connect the SSG to the ANT jack, and tune it to the same frequency, with 1 kHz modulation and ± 5 kHz deviation.
2. Connect the SINADER in parallel with the speaker, and adjust the SSG level for the proper level to provide for adjustment of T_{9501} to obtain the maximum SINAD ratio.

Squelch Threshold Preset

1. Set the front panel SQL control to the 1 o'clock position, and disconnect the SSG.
2. Adjust VR_{9501} to the squelch threshold while receiving noise.

FM Transmitter Coil

1. Set the MIC/DRIVE control to the 12 o'clock position, and connect the RF probe of the VTVM to the cathode of D_{9504} .
2. Adjust T_{9503} for maximum deflection on the VTVM.
3. Now move the RF probe to pin 2 of J_{9501} , and adjust VR_{9504} for a reading of 15 mV_{rms} on the VTVM.

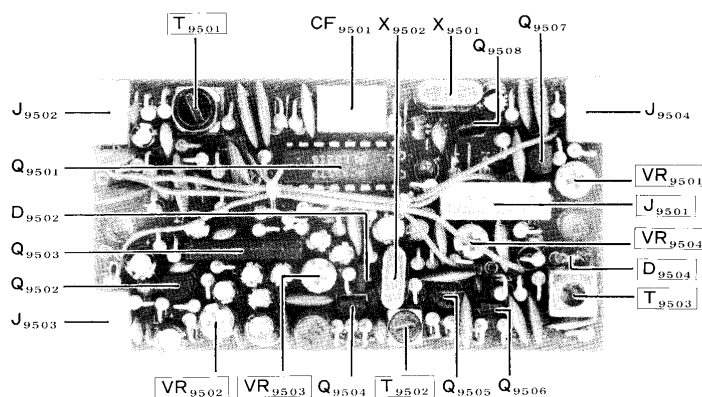
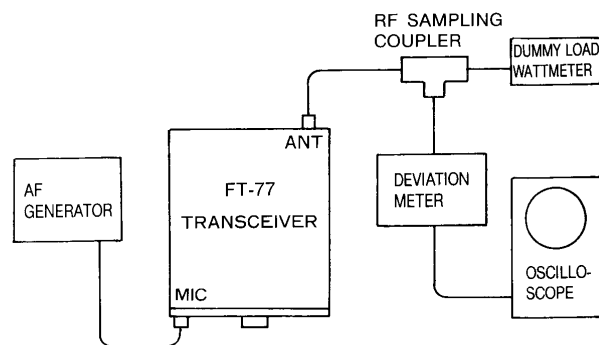

FM UNIT

FM Carrier Frequency

1. Connect the frequency counter to pin 2 of J_{9501} , and close the PTT line.
2. Adjust T_{9502} for 8.988.20 MHz on the counter.

Maximum Deviation

1. Connect the test equipment as shown in the figure, and set the output of the AF generator for 10 mV_{rms} at 1 kHz.
2. Adjust VR_{9503} for ± 4.5 kHz deviation, and then reduce the AF generator output level to 0.1 mV_{rms}.
3. Adjust VR_{9502} so that the deviation meter now shows ± 3.5 kHz.
4. Now set the AF generator for 10 mV and check that deviation is less than ± 5.0 kHz.

MAIN CHASSIS				RECEPTACLE		
Symbol No.	Part No.	Name & Description	J1	P0090026	QS-1B4M	Power
Q1	G3325620Y	TRANSISTOR 2SC2562Y	J4 (with wire)	T9204591		
			J6	P0090158	FM214-8SS	MIC
			J7, 9	P1090230	SG8022 #01	RECORD EXT SPKR
			J8	P1090003	SG7615	KEY
			J10	P1090134	SG7627	PHONE
		DIODE	J11	P1090034	D7-701B-00	ACC-2
D1, 2	G2090243	LED TLR210	J12, 16	P1090133	STR-01H	RF OUT, DC 8V
D3	G2090118	Schottky barrier 1SS97	J13	P1090194	FM-MR-M2	ANT
D4	G2090001	Si 10D1	J14	P1090033	D6-701B-00	ACC-1
			J15	P1090152	D8-703B-11	EXT VFO
		RESISTOR				
R3	J01245560	Carbon Film 1/4W TJ 56Ω			KNOB	
R1, 2	J01275101	" " 1/2W " 100Ω		R3085790	FT-50	Tuning
				R7085820	FT-50 Rubber Ring	
				R3085830	FT-18VK	MODE
		POTENTIOMETER		R3085850	FT-18XK	MIC, DRIVE
VR1	J61800016	K162A00B8E-5KBX2 5kΩ(B)X2		R3085860	FT-14XK	AF
VR2	J62800078	K16BA04C-5KB-10KA		R3085870	Push Knob	
		5kΩ(B)-10kΩ(A)		R3085910	FT-18WDNS	SQL
VR3	J60800097	K1611026TE-2KB 2kΩ(B)		R3077835B	FT-22VF	BAND
		CAPACITOR		R3086380A	FT-22XK	CLAR
C4	K50177223	Mylar 50WV 0.022μF (50F2U223)				
		AFC		RF UNIT		
CH1	L2030017	1.7mH 2.5A	Symbol No.	Part No.	Name & Description	
				F2509101	Printed Circuit Board	
				C025091A	PCB with Components	
		SWITCH				
S1	N0190118	SRN 1025S				
S2	N0190119	SRY 202B-1			FET	
			Q1001, 1002	G3801250	2SK125	
			Q1004, 1006	G4800730G	3SK73GR	
		METER				
M1	M0290040	Y-40-01				
			Q1003	G3303800Y	2SC380TM-Y	
			G1008	G3319230C	2SC1923-O	
			Q1007	G3324070	2SC2407	
		RELAY				
RL1	M1090018	G4W-11123A-B DC12V				
			Q1005	G2090135	DIODE QUAD ND487C2-3R	
		SPEAKER				
SP1	M4090043	SS-70 4Ω 3W				

		DIODE					POTENTIOMETER	
D1003	G2090239	Si	MA161		VR1001	J51745101	H0651A001-100B	100ΩB
D1001, 1002 1004-1049	G2090237	"	MA190					
CAPACITOR								
					C1039	K00172030	Ceramic Disc	50WV SL 3 pF (DD104SL030C50V)
		CRYSTAL FILTER						
XF1001	H1102070	8F-20A/S			C1001	K00173100	" " " "	10 pF (DD104SL100D50V)
					C1073, 1075	K00179008	" " " "	36 pF (DD104SL360J50V)
					C1056, 1057	K00175820	" " " "	82 pF (DD104SL820J50V)
THERMISTOR								
TH1001	G9090022	SDT09			C1066, 1074	K00175121	" " " "	120 pF (DD105SL121J50V)
					C1004	K00179023	" " " "	430 pF (DD109SL431J50V)
					C1002, 1005	K00175621	" " " "	620 pF (DD110SL621J50V)
RESISTOR								
R1007, 1024	J02245330	Carbon film	1/4W SJ	33Ω	C1008, 1011 1029, 1031 1035, 1041 1042, 1044 1055, 1062 1068, 1072	K13179008	" " " "	0.01μF (DD106F103Z50V)
R1004, 1027 1065, 1069 1070	J02245470	" "	" "	47Ω				
R1063	J01275470	" "	1/2W TJ	47Ω				
R1006, 1011- 1018, 1023 1038, 1040 1042, 1044 1046, 1048 1050, 1052 1071	J02245680	" "	1/4W SJ	68Ω	C1003, 1006 1007, 1009 1010, 1012 1014, 1016 1018, 1020 1022, 1024 1026, 1028 1030, 1032- 1034, 1036- 1038, 1040 1043, 1045- 1054, 1058 1060, 1061 1063, 1064 1067, 1069 1070	K13179010	" " " "	0.022μF (DD108-F223Z50V)
R1062	J01245680	" "	" TJ	68Ω				
R1020, 1030 1031, 1033 1060, 1068	J02245101	" "	" SJ	100Ω				
R1064	J01275101	" "	1/2W TJ	100Ω				
R1005, 1009	J02245151	" "	1/4W SJ	150Ω				
R1054, 1059	J02245331	" "	" "	330Ω				
R1002, 1003 1010, 1055- 1057, 1067	J02245471	" "	" "	470Ω				
R1001	J02245681	" "	" "	680Ω	C1065	K13179009	" " " "	0.047μF (DD110-F473Z50V)
R1028, 1037	J02245102	" "	" "	1kΩ				
R1021, 1025 1029	J02245222	" "	" "	2.2kΩ	C1013, 1015 1017, 1019 1021, 1025 1027	K40179014	Electrolytic	" " " " 10μF (50RE10)
R1026, 1039 1058, 1066	J02245332	" "	" "	3.3kΩ				
R1041, 1043 1053	J02245472	" "	" "	4.7kΩ	C1023, 1071	K40129004	" " " "	16WV 10μF (16RE-10)
R1019, 1034 1035, 1045	J02245103	" "	" "	10kΩ				
R1032, 1047 1049, 1051	J02245153	" "	" "	15kΩ				
INDUCTOR								
R1022	J02245223	" "	" "	22kΩ	L1003	L1190008	FL4H	2R2M 2.2μH
R1072	J02245333	" "	" "	33kΩ	L1013-1015	L1190113	FL3H	R22M 0.22μH
R1036	J02245154	" "	" "	150kΩ	L1012	L1190109	FL3H	R33M 0.33μH
R1008	J02245334	" "	" "	330kΩ	L1001, 1002	L1190011	FL4H	4R7K 4.7μH
R1061	J02245105	" "	" "	1MΩ		L9190037	Shield Case	

L1004-1011	L0190093	RC855-102K	1 mH		Q5000026	TP TERMINAL		
						TP-F		
		TRANSFORMER						
T1001, 1022	L0021325							
T1002	L0021350							
T1003	L0021306					IF UNIT		
T1004	L0021307				F2510101	Printed Circuit Board		
T1005	L0021308				C025101A	PCB with Components		
T1006	L0021309							
T1007	L0021310							
T1008	L0021311							
T1009	L0021312							
T1010	L0021313					FET		
T1011	L0021314			Q2001	G3802410G	2SK241GR		
T1012	L0021315			Q2002-2004 2021	G4800730G	3SK73GR		
T1013	L0021316							
T1014	L0021317							
T1015	L0021318							
T1016	L0021319							
T1017	L0021320							
T1018	L0021321					TRANSISTOR		
T1019, 1020	L0021351			Q2011, 2015	G3107331Q	2SA733AQ		
T1021	L0021328			Q2016-2020 2012-2014	G3303800Y	2SC380TM-Y		
					G3304580C	2SC458C		
		PIN JACK						
PJ1001	P1090210	TMP-JV						
						DIODE		
				D2014-2017	G2090244	Schottky barrier	1SS106	
				D2004	G2090245	Varactor	1SV103	
				D2001-2003 2005-2013 2018, 2019	G2090237	Si	MA190	
J1001-1006 1008-1010	P0090191	B2B-XH-A	2P	D2020	G2090246	Zener	RD6.2EB2	
J1011-1013	P0090192	B3B-XH-A	3P					
J1007	P0090201	B12B-XH-A	12P					
						THERMISTOR		
				TH2002	G9090023	SDT04		
				TH2001	G9090022	SDT09		
RL1001	M1190045	AG2013						
						RESISTOR		
		LAMP FUSE		R2038	J02245330	Carbon film	1/4W SJ	33Ω
PL1001	Q1000051	M1052.8.2	12V 150 mA	R2065, 2071 2077, 2097	J02245470	" "	" "	47Ω
				R2003, 2009 2012, 2019 2022, 2024 2026, 2029	J02245101	" "	" "	100Ω
		FERRITE BEADS						
FB1001	L9190001	RI 3x3-1		2031, 2048 2054, 2060				

R2092	J02245101	Carbon film	1/4W SJ	100Ω			CAPACITOR
R2006, 2069 2075, 2078 2080	J02245221	" "	" "	220Ω	C2008, 2077	K00172040	Ceramic Disc 50WV SL 4 pF (DD104SL040C50V)
R2013, 2018 2023, 2091 2095	J02245331	" "	" "	330Ω	C2006, 2034	K00173100	" " " " 10 pF (DD104-SL100D50V)
R2004, 2027 2096	J02245471	" "	" "	470Ω	C2026, 2030 2055, 2059 2066, 2067 2082, 2086	K00175101	" " " " 100 pF (DD105SL101J50V)
R2002, 2016 2040, 2041 2046, 2053 2088	J02245102	" "	" "	1kΩ	C2094	K12171102	" " " " 0.001μF (DD104E102P50V)
R2007, 2008 2015, 2030 2044, 2066 2070, 2072 2076, 2081 2094	J02245222	" "	" "	2.2kΩ	C2002, 2007 2013, 2014 2020, 2021 2025, 2031 2036, 2038 2048, 2084 2091	K13179008	" " " " 0.01μF (DD106F103Z50V)
R2001, 2028 2034, 2036 2050, 2063 2082-2084 2093	J02245332	" "	" "	3.3kΩ	C2001, 2003- 2005, 2009 2011, 2012 2015-2019 2022-2024 2027-2029 2032, 2033 2035, 2037 2040-2043 2045, 2047 2049, 2052- 2054, 2056 2058, 2060 2063, 2065 2068-2076 2078, 2079 2083, 2085 2087-2090 2092	K13179010	" " " " 0.022μF (DD108F223Z50V)
R2010, 2014	J02245472	" "	" "	4.7kΩ			
R2056	J02245562	" "	" "	5.6kΩ			
R2020, 2025 2058, 2059 2068, 2074 2079, 2086	J02245682	" "	" "	6.8kΩ			
R2005, 2017 2021, 2033 2035, 2039 2042, 2043 2064, 2067 2073, 2085 2087, 2090	J02245103	" "	" "	10kΩ			
R2011, 2089	J02245223	" "	" "	22kΩ	C2039	K19149025	Semiconductor Ceramic 25WV 0.1μF (UAT10X104K-L45AE)
R2051	J02245333	" "	" "	33kΩ			
R2032, 2037 2052	J02245473	" "	" "	47kΩ	C2081	K40179010	Electrolytic 50WV 0.47μF (S0RE47)
R2055	J02245104	" "	" "	100kΩ	C2057, 2064	K40179013	" " " " 1μF (S0RE1)
R2049	J02245334	" "	" "	330kΩ	C2044	K40179009	" " " " 2.2μF (S0RE2R2)
R2062	J02245474	" "	" "	470kΩ	C2010, 2046 2050, 2062 2093	K40179014	" " " " 10μF (S0RE10)
R2061	J02245684	" "	" "	680kΩ			
R2047	J02245105	" "	" "	1MΩ			
R2045, 2057	J02245155	" "	" "	1.5MΩ			
					C2051	K70167684	Tantalum 35WV 0.68μF (CS15E1VR68M)
					C2061	K70167105	" " " " 1μF (CS15E1V010M)
		POTENTIOMETER					
VR2001	J51745331	H0651A004-330B		330ΩB	C2080	K70167225	" " " " 2.2μF (CS15E1V2R2M)
VR2005	J51745222	H0651A009-2.2KB		2.2kΩB			

TRIMMER CAPACITOR				PLL UNIT	
TC3002	K91000108	CTZ51A157	50WV 6 pF	F2510103	Printed Circuit Board
TC3003	K91000085	CTZ51C122	" 10 pF	C025103A	PCB with Components
TC3001, 3004	K91000086	CTZ51E117	" 20 pF		
TC3005	K91000089	CTZ51G113	" 50 pF		
					IC
				Q4031	G1090087 MC4044P
				Q4027	G1090081 TA7310P
L3004	L0190096	RF3-855-180J	18μH	Q4020	G1090084 μPC78L05
L3001-3003 3005, 3006	L0190084	RC855-181K	180μH		
L3008	L0190093	RC855-102K	1 mH		
L3007	L1190102	S-104K	100 mH		
					FET
				Q4022	G3802410G 2SK241GR
					TRANSFORMER
T3001	L0021327				
					TRANSISTOR
				Q4001-4019	G3110050K 2SA1005K
				Q4032-4034	G3307320G 2SC732TMGR
				Q4021	G3319230O 2SC1923-O
				Q4023-4026 4028-4030 4035	G3324580Y 2SC2458Y
					CONNECTOR
J3010, 3011 3015-3017	P0090191	B2B-XH-A	2P		
J3002, 3003 3005, 3007 3013, 3018 3019	P0090192	B3B-XH-A	3P		
J3008	P0090193	B4B-XH-A	4P		
J3001, 3006 3009, 3012 3014	P0090194	B5B-XH-A	5P	D4036	G2090118 Schottky barrier 1SS97
J3004	P0090195	B6B-XH-A	6P	D4016, 4018 4020, 4022 4024, 4026 4028, 4030	G2090245 Varactor 1SV103
				D4001-4015 4017, 4019 4021, 4023 4025, 4027 4029, 4031- 4035, 4037	G2090237 Si MA190
					DIODE
					CRYSTAL SOCKET
XS3001	P3090002	S2-101P-00			
					SWITCH
S3001	N6090040	SSS323L4			
S3002	N6090041	SSS312L4NS			CRYSTAL
			X4001	H0102490	17.9845 MHz
			X4002	H0102491	21.4845 MHz
			X4003	H0102492	24.4875 MHz
			X4004	H0102493	28.4875 MHz
			X4005	H0102494	32.4875 MHz
			X4006	H0102495	35.4875 MHz
			X4007	H0102496	38.9875 MHz
			X4008	H0102497	42.4875 MHz
			X4009	H0102498	42.9875 MHz
			X4010	H0102499	43.4875 MHz
			X4011	H0102500	43.9875 MHz
					TP TERMINAL
TP3001, 3002	Q5000016	TP-E			
TP3003	Q5000026	TP-F MK-10160			

RESISTOR			4152, 4153			
R4095, 4118 4125, 4131 4140	J02245100	Carbon film 1/4W SJ 10Ω	R4124, 4138	J02245153	Carbon film 1/4W SJ 15kΩ	
R4090, 4121 4134, 4149	J02245330	" " " " 33Ω	R4003, 4009 4013, 4019 4024, 4029 4034, 4039 4044, 4049 4054, 4057 4062, 4067 4072, 4081 4086, 4091 4096, 4123 4132, 4137	J02245223	" " " " 22kΩ	
R4114, 4127	J02245680	" " " " 68Ω	R4058, 4059	J02245333	" " " " 33kΩ	
R4001, 4007 4012, 4017 4022, 4027 4032, 4037 4042, 4047 4052, 4061 4066, 4071 4075, 4076 4077, 4080 4082, 4085 4087, 4092 4101, 4105 4107, 4122 4126, 4129 4139, 4151	J02245101	" " " " 100Ω	R4143	J02245473	" " " " 47kΩ	
R4070	J02245151	" " " " 150Ω	R4146	J02245104	" " " " 100kΩ	
R4060, 4065 4119, 4133 4135	J02245221	" " " " 220Ω	R4142	J02245474	" " " " 470kΩ	
R4106	J02245331	" " " " 330Ω	CAPACITOR			
R4098, 4102 4108, 4120 4154	J02245471	" " " " 470Ω				
R4147	J02245681	" " " " 680Ω	C4076, 4077	K06172050	Ceramic 50WV UJ 5 pF (DD104UJ050C50V)	
R4002, 4008 4013, 4018 4023, 4028 4033, 4038 4043, 4048 4053, 4111 4113, 4115 4128, 4136 4148	J02245102	" " " " 1kΩ	C4065	K06173100	" " " " 10 pF (DD104UJ100D50V)	
R4150	J01245102	" " " TJ 1kΩ	C4062	K06175120	" " " " 12 pF (DD104UJ120J50V)	
R4031, 4104	J02245152	" " " SJ 1.5kΩ	C4021, 4024 4027, 4030 4033, 4036 4039, 4042 4056, 4059 4083	K06175150	" " " " 15 pF (DD104UJ150J50V)	
R4005, 4006 4041, 4046 4051, 4056 4109, 4116 4132, 4141	J02245222	" " " " 2.2kΩ	C4053	K06175180	" " " " 18 pF (DD104UJ180J50V)	
R4011, 4016 4021, 4026 4099	J02245332	" " " " 3.3kΩ	C4012, 4015 4018, 4068	K06175220	" " " " 22 pF (DD104UJ220J50V)	
R4117, 4130	J02245472	" " " " 4.7kΩ	C4063	K02175270	" " CH 27 pF (DD105CH270J50V)	
R4144, 4145	J02245682	" " " " 6.8kΩ	C4049	K02175330	" " " " 33 pF (DD105CH330J50V)	
R4004, 4010 4015, 4020 4025, 4030 4035, 4040 4045, 4050 4055, 4097 4100, 4103 4110, 4112	J02245103	" " " " 10kΩ	C4060, 4066 4069	K02175390	" " " " 39 pF (DD105CH390J50V)	
			C4106	K00175390	" " SL 39 pF (DD104SL390J50V)	
			C4045, 4050	K02175470	" " CH 47 pF (DD106CH470J50V)	
			C4054	K02175560	" " " " 56 pF (DD106CH560J50V)	
			C4107, 4108	K00179011	" " SL 62 pF (DD104SL620J50V)	

C4051	K06175680	Ceramic	50WV UJ	68 pF			INDUCTOR	
			(DD105UJ680J50V)		L4003	L1190116	FL4H-R33M	0.33μH
C4080, 4081	K00175680	"	"	68 pF	L4005	L1190008	FL4H-2R2K	2.2μH
			(DD104SL680J50V)		L4009-4011	L1190023	FL5H-220K	22μH
C4057	K02175820	"	"	82 pF	L4001, 4002	L0190084	RC855-181K	180μH
			(DD107CH820J50V)		4006, 4008			
C4047	K06175101	"	"	100 pF	4012			
			(DD106UJ101J50V)		L4007, 4013	L0190093	RC855-102K	1 mH
C4046	K02175101	"	"	100 pF				
			(DD107CH101J50V)					
C4084	K06175151	"	"	150 pF				
			(DD107UJ151J50V)					
C4092, 4093	K00175471	"	"	470μF			TRANSFORMER	
			(DD109SL471J50V)		T4001	L0021331		
C4001-4011	K13179008	"	"	0.01μF	T4002	L0021332		
4013, 4016			(DD106F103Z50V)		T4003	L0021333		
4019, 4022					T4004	L0021334		
4025, 4029					T4005	L0021335		
4032, 4035					T4006	L0021336		
4038, 4041					T4007	L0021337		
4044, 4048					T4008-4011	L0021338		
4052, 4055					T4012	L0021339		
4058, 4061					T4013	L0021340		
4064, 4067					T4014	L0021341		
4070, 4079					T4015	L0021342		
4085-4087					T4016	L0021343		
4089, 4090					T4017	L0021344		
4095, 4098					T4018	L0021345		
4101, 4102					T4019	L0021346		
4110, 4113								
4121, 4122								
4124								
C4014, 4017	K13179010	"	"	0.022μF			CONNECTOR	
4020, 4023			(DD109F223Z50V)		J4002, 4005	P0090191	B2B-XH-A	2P
4026, 4028					J4003	P0090192	B3B-XH-A	3P
4031, 4034					J4004, 4006	P0090193	B4B-XH-A	4P
4037, 4040					J4001	P0090201	B12B-XH-A	12P
4043, 4073								
4074, 4078								
4082, 4088								
4091, 4094								
4096, 4097								
4099, 4100								
4103-4105								
4111, 4112					PJ4001	P1090210	TMP-JV	
4114, 4116								
4118, 4123								
4125, 4126								
C4071, 4115, 4120	K19149025	Semiconductor Ceramic	25WV	0.1μF			TP TERMINAL	
			(UAT10X104K-L4SAE)		TP4001, 4003	Q5000026	TP-F	
C4072, 4117 4119	K40179014	Electrolytic	50WV	10μF				
			(50RE10)					
C4075	K40149022	"	25WV	47μF				
			(25RE47)					

DISPLAY UNIT			R5012	J02245472	Carbon film	1/4W SJ	4.7kΩ
Symbol No.	Part No.	Name & Description	R5001-5009	J02245103	" "	" "	10kΩ
	F2509102	Printed Circuit Board	5025-5051				
	C025092A	PCB with Components	5053, 5054				
			R5010, 5011	J02245104	" "	" "	100kΩ
			5052				
		IC					
Q5024	G1090249	MSL9520RS					
						BLOCK RESISTOR	
			RB5001	J40900003	RK1/16B7E	100kΩ	
			RB5002	J40900019	RK1/16K8R	100kΩ	
		TRANSISTOR					
Q5004-5006	G3107331Q	2SA733AQ					
5011-5023							
Q5001-5003	G3304580C	2SC458C					
5025			C5018	K02172050	Ceramic	50WV CH	5 pF
Q5008, 5009	G33192300	2SC1923-O				(DD104CH050J50V)	
Q5007	G3319590Y	2SC1959Y	C5019	K02175470	" "	" "	47 pF
						(DD106CH470J50V)	
			C5010, 5012	K13179008	" "	" "	0.01μF
			5017			(DD106F103Z50V)	
			C5006, 5009	K13179010	" "	" "	0.022μF
			5011, 5013			(DD108F223Z50V)	
			5014, 5016				
		DIODE					
D5002, 5004	G2090239	Si MA161					
5005			C5002, 5003	K19149017	Semiconductor Ceramic	25WV0.022μF	
D5007-5012	G2090237	" MA190				(UAT06X223K-45AE)	
D5006	G2090193	Zener RD5.6EB3	C5004	K40179011	Electrolytic	50WV	3.3μF
D5001	G2090154	" RD7.5EB1				(S0RE3R3)	
D5003	G2090166	" RD8.2EB1	C5007, 5008	K40179014	" "	" "	10μF
			5015			(S0RE10)	
			C5005	K40179022	" "	" "	22μF
						(S0RE22)	
			C5001	K40149003	" "	25WV	100μF
						(25RE100)	
		FCD					
DS5001	G6090030	FIP 8B7					
						TRIMMER CAPACITOR	
		CRYSTAL	TC5001	K91000089	CTZ51G113	50WV	50 pF
X5001	H0102272	HC-18/U 6.5536 MHz					
						COIL	
		RESISTOR	L5001	L2190001	SN8S-500		
R5055	J02245150	Carbon film 1/4W SJ					15Ω
R5020	J02245330	" " " "					33Ω
R5023	J01275470	" " " TJ					47Ω
R5013, 5017	J02245101	" " " SJ					100Ω
5018							
R5021	J02245151	" " " "					150Ω
R5022	J02245221	" " " "					220Ω
R5015, 5019	J02245471	" " " "					470Ω
5024							
R5016	J02245681	" " " "					680Ω
R5014	J02245152	" " " "					1.5kΩ
						TRANSFORMER (DC-DC)	
			T5001	L3030077	MPS-160		

		SWITCH		C8018	K02179014	Ceramic 50WV CH 36 pF (DD105-257CH360J50V02)	
S7001	N0190120	SRV202B-2					
S7002	N6090042	SSS313L4		C8010, 8012	K10179034	" " 470 pF (UP125B471K-NA)	
				C8007-8009	K15179001	" " 0.01µF (TP125X103N-NA)	
				C8011	K10179035	" " 0.01µF (UP125B102K-NA)	
		RELAY					
RL7001	M1190046	AG2033					
						VARIABLE CAPACITOR	
				VC8001	K90000024	C521R112	
VFO UNIT							
Symbol No.	Part No.	Name & Description					
	F0002348A	Printed Circuit Board					
	C023481A	PCB with Components					
						TRIMMER CAPACITOR	
				TC8001	K91000103	PSS-100-10P 10 pF	
				TC8002	K91000090	PS-100 10 pFX2	
		IC					
Q8001	G1090390	VFO-1					
						INDUCTOR	
				L8001	L0021213		
				L8005, 8006	L1190131	LAL04NA1R8M 1.8µH	
				L8002, 8004	L1190132	LAL04NA221K 220µH	
				L8003	L1190090	LAL04NA102K 1 mH	
		DIODE					
D8001	G2022360	Varactor 1S2236					
						CONNECTOR	
				J8001	P0090149	PI021-05M	
		RESISTOR					
R8002	J01245561	Carbon film 1/4W TJ 560Ω					
R8001	J01245103	" " " " 10kΩ					
		CAPACITOR		PUSH SW UNIT			
C8016	K06172020	Ceramic 50WV UJ 2 pF (DD104UJ020C50V)		Symbol No.	Part No.	Name & Description	
C8001, 8004	K06179052	" " " " 8.2 pF (UP125UJ8R2K-NA)			F2510104	Printed Circuit Board	
C8013	K02179062	" " " " CH 8.2 pF (UP125CH8R2J-NA)			C025104A	PCB with Components	
C8015	K02173100	" " " " 10 pF (DD104CH100D50V02)					
C8014	K02179065	" " " " 18 pF (UP125CH180J-NA)		D8201	G2090001	DIODE 10D1	
C8002	K06179053	" " " " UJ 22 pF (UP125UJ220K-NA)					
C8003, 8005	K02179063	" " " " CH 22 pF (UP125CH220J-NA)					
C8006	K02179064	" " " " 33 pF (UP125CH330J-NA)				RESISTOR	
				R8201, 8203	J02245681	Carbon film 1/4W SJ 680Ω	
				R8202	J02245103	" " " " 10KΩ	

		SWITCH	R9017, 9021	J20335390	Metallic film 2W	39Ω
S8201	N4090075	SUJ71A	9022		(ERG-2ANJ390)	
			R9023	J20335680	" " "	68Ω
					(ERG-2ANJ680)	
			R9001	J02245121	Carbon film 1/4W SJ	120Ω
					(RD14SJ121)	
		PLUG	R9014, 9015	J10276121	Carbon Composition 1/2W GK	120Ω
P8201	T9204586				(RC12GK121)	
(with wire)			R9024	J02245271	Carbon film 1/4W SJ	270Ω
P8202	T9204587				(RD14SJ271)	
(with wire)			R9003, 9004	J10276331	Carbon Composition 1/2W GK	330Ω
					(RC12GK331)	
			R9008	J10276102	" " " "	1kΩ
					(RC12GK102)	
			R9005	J01245152	Carbon film 1/4W TJ	1.5kΩ
					(RD14TJ152)	
100W PA UNIT						
Symbol No.	Part No.	Name & Description				
	F0002013B	Printed Circuit Board				
	C0020130	PCB with Components				
	C020135A		VR9001	J51727222	POTENTIOMETER	
					H1021A-222	2.2kΩ(B)
		IC				
Q9006	G1090204	μPC7808H			CAPACITOR	
			C9035	K30279024	Dipped Mica 50WV	56 pF
					(DM15D560K5)	
			C9044	K30275910	" " 500WV	91 pF
					(LCQ12910J5)	
		TRANSISTOR	C9032, 9034	K30279122	" " "	470 pF
Q9001	G3315890	2SC1589			(DM19D471J5)	
Q9004, 9005	G3322900	2SC2290	C9043	K30279045	" " "	560 pF
Q9002, 9003	G3323950	2SC2395			(DM19D561K5)	
Q9007	G3402350Y	2SD235Y	C9033	K30279046	" " "	620 pF
					(DM19D621K5)	
			C9028	K30279092	" " "	750 pF
					(DM19D751J5)	
			C9027, 9029	K30279118	" " "	5000 pF
					(DM19D502J5)	
		DIODE	C9005, 9006	K10179038	Ceramic 50WV	0.0047μF
D9002-9005	G2090002	Si 10D10			(DD108B472K50V)	
D9001	G2090021	Zener YZ033	C9002, 9010	K10179024	" " "	0.01μF
			9011, 9016		(CDS080XB103K50V)	
			9036			
		RESISTOR	C9001, 9003	K13179009	" " "	0.047μF
R9026, 9027	J02245010	Carbon film 1/4W SJ	9007, 9008		(DD110F473Z50V)	
		(RD14SJ1R0)	9012, 9014			
R9009, 9011	J10276159	Carbon Composition 1/2W GK	9017, 9019			
9016, 9018		(RC12GK1R5)	9021, 9023			
R9006	J10276479	" " " "	9026, 9030			
		(RC12GK4R7)	9031			
R9007, 9019	J10276180	" " " "	C9040, 9041	K50177683	Myalr " "	0.068μF
9020		(RC12GK180)			(50F2U683M)	
R9012, 9013	J10276240	" " " "	C9037	K19179001	Ceramic " "	0.1μF
		(RC12GK240)			(RSB305YF104Z6L5)	
R9002	J02245330	Carbon film 1/4W SJ	C9039	K50177104	Maylar " "	0.1μF
		(RD14SJ330)			(50F2U104M)	
R9010	J10276390	Carbon Composition 1/2W GK				
		(RC12GK390)				

C9004, 9009	K23170002	Ceramic chip 50WV (GR43Y5V104Z50V09)	0.1 μ F			MOTOR
C9022	K70120006	Tantalum 16WV (489D335X0016B1)	3.3 μ F		M2190004 R3056970	MDN-7R1 RADIAL FAN
C9013, 9015 9018, 9020 9024, 9025 9042	K70120002	" " (489D106X0016C1)	10 μ F			
C9038	K40169003	Electrolytic 35WV (35RE330)	330 μ F		L9190010	FERRITE BEADS RI-9.3X4.8-5
		INDUCTOR				
L9001-9004	L1020035A			10W PA UNIT		
L9005	L1020015			Symbol No.	Part No.	Name & Description
L9006	L1020395A				F0002149B	Printed Circuit Board
L9007	L1020015				C021495A	PCB with Components
		TRANSFORMER				IC
T9001	L0020289A			Q9205	G1090080	μ PC78L08
T9002	L0020631C					
T9003	L0020632					
						TRANSISTOR
				Q9201	G3321660	2SC2166
				Q9202, 9203	G3325090	2SC2509
		PLUG		Q9204	G3408820Q	2SD882Q
P9001 (with wire)	T9309200					
P9002 (")	T9204589					
P9004 (")	T9309200					
J9001 (")	T9309200			D9202	G9090017	Varistor MV11
	T9309200A			D9201	G2090021	Zener YZ033
						DIODE
						RESISTOR
		THERMAL GUARD		R9208, 9210	J01275150	Carbon film 1/2W TJ 15 Ω
TS9001	N7090027	OHD-50M		R9207	J01275390	" " " " 39 Ω
				R9205	J01245151	" " 1/4W " 150 Ω
	Q5000035	Wrapping terminal B		R9209, 9211	J01275151	" " 1/2W " 150 Ω
	Q5000011	Wrapping terminal C		R9215	J02245221	" " 1/4W " 220 Ω
				R9201	J01245271	" " " " 270 Ω
				R9202	J01245331	" " " " 330 Ω
				R9214	J02245331	" " " " 330 Ω
				R9203	J01245821	" " " " 820 Ω
				R9206	J01275102	" " 1/2W " 1k Ω
	Q5000006	STK-97				
	Q9000029	INSULATOR				
	Q9000030	Mylar Sheet				

		POTENTIOMETER		P9203	T9309400	
VR9201	J51727471	H1021A-471	470Ω(B)	(with wire)		
				P9204	T9309300	
				(")		
				P9201	T9309300	
				(")		
		CAPACITOR			T9309300A	
C9217	K30276680	Dipped Mica	500WV 68 pF (LCQ12 680K5)		Q5000011	Wrapping terminal C
C9215, 9216	K30276221	" "	" " 220 pF (LCQ17 221K5)			
C9226	K30276391	" "	" " 390 pF (LCQ17 391K5)			
C9218	K10179016	Ceramic	50WV 0.001μF (DB200YB102K5L5)		Q9000029	INSULATOR
C9202	K10179038	" "	" " 0.0047μF (DD108B472K50V)			
C9210	K10179024	" "	" " 0.01μF (CDS08XB103K50V)			
C9201, 9203 9205-9207 9209, 9211 9213, 9214 9219, 9223 9225, 9227	K13179009	" "	" " 0.047μF (DD110F473Z50V)		Q9000192	THERMAL CONDUCTOR 30F-TO-220
C9220, 9221	K50177154	Mylar	50WV 0.15μF (50F2U154)		S5000037	EYELET 2.0X3.0X3.3BK
C9204, 9224	K40129004	Electrolytic	16WV 10μF (16RE10)			
C9208, 9212	K40129008	" "	" " 33μF (16RE33)			
C9222	K40129007	" "	" " 100μF (16RE100)			
				MARKER UNIT(OPTION)		
				Symbol No.	Part No.	Name & Description
					F2511000A	Printed Circuit Board
					C025110A	PCB with Components
		INDUCTOR				
L9205	L1020666		2.4μH			
L9202	L1190009	FL4H-3R3M	3.3μH			
L9201	L1190027	FL5H-390K	39μH			
L9203, 9206	L1020032					IC
L9204	L1020015			Q9402	G1090342	MB84024BM-G
		TRANSFORMER				TRANSISTOR
T9201	L0020789A			Q9401-9403	G3324580Y	2SC2458Y
T9202	L0020833A					
T9203	L0020834A					
						CRYSTAL
				X9401	H0100260	HC-6/W 3200 kHz
		PLUG				
P9201 (with wire)	T9309300					
P9202 (")	T9204589					

		RESISTOR			TRANSISTOR
R9408	J02245101	Carbon film 1/4W SJ 100Ω	Q9508	G3107331Q	2SA733AQ
R9404	J02245221	" " " " 220Ω	Q9505	G3303800Y	2SC380TM-Y
R9405	J02245102	" " " " 1kΩ	Q9507	G3304580C	2SC458C
R9403	J02245222	" " " " 2.2kΩ	G9502	G3307320G	2SC732TM-GR
R9402	J02245103	" " " " 10kΩ	Q9504, 9506	G3324580Y	2SC2458Y
R9401	J02245223	" " " " 22kΩ			
R9406	J02245104	" " " " 100kΩ			
					DIODE
			D9501, 9504-9507	G2090027	Si 1SS53
			D9502	G2090180	Varactor FC53M-5
C9406	K00173100	Ceramic 50WV SL 10 pF (DD104SL100D50V02)	D9503	G9090005	Varistor MV103
C9402	K02175180	" " CH 18 pF (DD104CH180J50V02)			
C9405	K00175330	" " SL 33 pF (DD104SL330J50V02)			
C9404	K00175271	" " " 270 pF (DD107SL271J50V02)			CRYSTAL
C9403	K00175511	" " " 510 pF (DD109SL511J50V02)	X9501	H0102275A	HC-18/U 9.4432 MHz
C9401	K19149025	Semiconductor Ceramic 25WV 0.1μF (UAT10X104K-L45AE)	X9502	H0102502	HC-18/U 8.9882 MHz
					CERAMIC FILTER
			CF9501	H3900204	LF-H15B
					TRIMMER CAPACITOR
TC9401	K91000086	CTZ51E117 50WV 20 pF			
					RESISTOR
			R9525	J02245470	Carbon film 1/4W SJ 47Ω
			R9519, 9522	J02245101	" " " " 100Ω
			9537, 9538		
			9543, 9549		
J9401	P0090191	MINI CONNECTOR B2B-XH-A 2 Pin	9550		
			R9541	J02245331	" " " " 330Ω
			R9528	J02245561	" " " " 560Ω
			R9510, 9552	J02245681	" " " " 680Ω
			R9506, 9520	J02245102	" " " " 1kΩ
P9401	T9204590	PLUG with wire XHP-02	9536, 9544		
			9545, 9554		1.5kΩ
			R9502, 9503	J02245152	" " " " 2.2kΩ
			9524		
			R9529, 9530	J02245222	" " " " 3.3kΩ
			R9521, 9523	J02245332	" " " " 4.7kΩ
			R9507, 9511	J02245472	" " " " 5.6kΩ
			9512, 9516		10kΩ
			9540, 9542		
			R9548	J02245562	" " " " 12kΩ
			R9527	J02245103	" " " " 18kΩ
			R9509	J02245123	" " " " 22kΩ
			R9539, 9551	J02245183	" " " " 18KΩ
			R9513, 9515	J02245223	" " " " 22KΩ
			9531, 9534		
					IC
Q9501	G1090145	MC3357P	R9504, 9517	J02245333	" " " " 33kΩ
Q9503	G1090072	μPCS77H	9533, 9535		

R9526	J02245393	Carbon film	1/4W SJ	39kΩ	9529, 9539			
R9505	J02245563	" "	" "	47kΩ	C9551	K40129016	Electrolytic 16WV (16RE22)	22μF
R9532	J02245563	" "	" "	56kΩ				
R9501	J02245683	" "	" "	68kΩ	C9521, 9525	K40129008	" "	33μF
R9514	J02245104	" "	" "	100kΩ	9552		(16RE33)	
R9518	J02245124	" "	" "	120kΩ				
R9547	J02245224	" "	" "	220kΩ				
R9508	J02245274	" "	" "	270kΩ				
							TRANSFORMER	
					T9501	L0190002		
					T9502	L0021349		
					T9503	L0021348		
							POTENTIOMETER	
VR9503	J51745152	H0651A008-1.5KB		1.5kΩB				
VR9504	J51745222	H0651A009-2.2KB		2.2kΩB				
VR9502	J51745332	H0651A010-3.3KB		3.3kΩB				
VR9501	J51745103	H0651A013-10KB		10kΩB				
							INDUCTOR	
					L9501	L1190115	S-154	150 mH
							CAPACITOR	
C9507	K00173100	Ceramic	50WV SL	10 pF				
				(DD104SL100-D50V02)				
C9540	K00175220	" "	" "	22 pF			MINI CONNECTOR	
				(DD104SL220J50V02)	J9501	P0090195	B6B-XH-A	6 Pin
C9502	K02175330	" "	CH	33 pF	J9502-9504	P0090192	B3B-XH-A	3 Pin
				(DD105CH330J50V02)				
C9503	K06175820	" "	UJ	82 pF				
				(DD106UJ820J50V02)				
C9517, 9518 9545	K00175101	" "	SL	100 pF				
				(DD105SL101J50V02)			CONNECTION PLUG	
C9535, 9536	K06179018	" "	UJ	330 pF	P9501/9503	T9204593	with wire	
				(DD110UJ331J50V02)	P9502/9504	T9204594	"	
C9520, 9526 9534	K12171102	" "	E	0.001μF				
				(DD104E102P50V02)				
C9501	K13179008	" "	F	0.01μF				
				(DD106F103Z50V02)				
C9505, 9537 9538, 9541- 9544, 9546 9547, 9550	K13170223	" "	" "	0.022μF				
				(DD109F223Z50V02)				
							ACCESSORIES	
					Symbol No.	Part No.	Name & Description	
C9510, 9512	K19149001	Semiconductor Ceramic	25WV0.001μF				FUSE	
			(UAT04X102K-L05AE)			Q0000009	20A	(100W MODEL)
C9516	K19149005	" "	" " 0.0022μF			Q0000012	6A	(10W MODEL)
			(UAT04X222K-L05AE)					
C9523	K19149007	" "	" " 0.0033μF					
			(UAT05X332K-L05AE)					
C9530, 9531	K19149019	" "	" " 0.033μF					
			(UAT08X333K-L45AE)				POWER CORD	
C9506, 9508 9509, 9511 9514, 9549	K19149025	" "	" " 0.1μF			T9014420	100W MODEL	
			(UAT10X104K-L45AE)			T9014506	10W MODEL	
C9519	K70167105	Tantalum	35WV	1μF		R7054630A	EXTENDER LEG	
			(CS15E1V010M)			R3086910	STAND	
C9548	K70127225	" "	16WV	2.2μF				
			(CS15E1C2R2M)					
C9515, 9522 9532, 9533	K40179001	Electrolytic	50WV	1μF				
			(50RC ₂ -1)					
C9504, 9524 9527, 9528	K40129012	" "	16WV	10μF				
			(50RC ₂ -10)					